

# User's Manual

## **BEWARD STW-8P4**

*8-Port 10/100Mbps with*

*4-Port PoE*

*Web Smart Ethernet Switch*

## Trademarks

Copyright © BEWARD 2014.

Contents subject to revision without prior notice.

BEWARD is a registered trademark of BEWARD R & D Co., Ltd . All other trademarks belong to their respective owners.

## Disclaimer

BEWARD Technology does not warrant that the hardware will work properly in all environments and applications, and makes no warranty and representation, either implied or expressed, with respect to the quality, performance, merchantability, or fitness for a particular purpose.

BEWARD has made every effort to ensure that this User's Manual is accurate; BEWARD disclaims liability for any inaccuracies or omissions that may have occurred.

Information in this User's Manual is subject to change without notice and does not represent a commitment on the part of BEWARD. BEWARD assumes no responsibility for any inaccuracies that may be contained in this User's Manual. BEWARD makes no commitment to update or keep current the information in this User's Manual, and reserves the right to make improvements to this User's Manual and/or to the products described in this User's Manual, at any time without notice.

If you find information in this manual that is incorrect, misleading, or incomplete, we would appreciate your comments and suggestions.

## FCC Warning

This equipment has been tested and found to comply with the limits for a Class A digital device, pursuant to Part 15 of the FCC Rules. These limits are designed to provide reasonable protection against harmful interference when the equipment is operated in a commercial environment. This equipment generates, uses, and can radiate radio frequency energy and, if not installed and used in accordance with the Instruction manual, may cause harmful interference to radio communications. Operation of this equipment in a residential area is likely to cause harmful interference in which case the user will be required to correct the interference at his own expense.

## CE Mark Warning

This is a Class A product. In a domestic environment, this product may cause radio interference, in which case the user may be required to take adequate measures.

## Energy Saving Note of the Device

This power required device does not support Standby mode operation.

For energy saving, please remove the power cable to disconnect the device from the power circuit.

Without removing power cable, the device will still consuming power from the power source. In the view of Saving the Energy and reduce the unnecessary power consuming, it is strongly suggested to remove the power connection for the device if this device is not intended to be active.

## WEEE Warning



To avoid the potential effects on the environment and human health as a result of the presence of hazardous substances in electrical and electronic equipment, end users of electrical and electronic equipment should understand the meaning of the crossed-out wheeled bin symbol. Do not dispose of WEEE as unsorted municipal waste and have to collect such WEEE separately.

## Revision

BEWARD 8-Port 10/100Mbps with 4-Port PoE Web Smart Ethernet Switch User's Manual

**FOR MODEL:** STW-8P4

**REVISION:** 1.1 (NOV .2014)

**TABLE OF CONTENTS**

<b>1. INTRODUCTION</b> .....	<b>5</b>
1.1 CHECKLIST .....	5
1.2 ABOUT THE SWITCH .....	5
1.3 FEATURES .....	5
1.4 SPECIFICATION .....	7
<b>2. HARDWARE DESCRIPTION</b> .....	<b>9</b>
2.1 FRONT PANEL .....	9
2.2 REAR PANEL .....	10
2.3 HARDWARE INSTALLATION .....	11
2.4 DESKTOP INSTALLATION .....	12
2.5 RACK MOUNTING (OPTIONAL RACK KITS).....	13
2.6 PRODUCT APPLICATION .....	14
2.7 POWER OVER ETHERNET POWERED DEVICE .....	15
<b>3 MANAGEMENT</b> .....	<b>16</b>
3.1 OVERVIEW .....	16
3.2 REQUIREMENTS .....	16
3.3 MANAGEMENT METHOD .....	16
3.3.1 Web Management .....	16
3.3.2 BEWARD Smart Discovery Utility .....	18
<b>4. WEB CONFIGURATION</b> .....	<b>20</b>
4.1 MAIN MENU .....	20
4.2 WEB PANEL .....	21
4.3 SYSTEM .....	21
4.3.1 System Information .....	22
4.3.2 IP Configuration .....	22
4.3.3 Password Setting .....	23
4.3.4 Firmware Upgrade .....	24
4.3.5 Configuration Setting .....	26
4.3.6 Alert Trap Configuration .....	28
4.3.7 System Reboot .....	29
4.4 PORT MANAGEMENT .....	30
4.4.1 Port Configuration .....	30
4.4.2 Port Status .....	31
4.4.3 Port Security .....	32
4.5 VLAN .....	34
4.5.1 VLAN Group .....	37
4.5.2 VLAN Per Port Setting .....	41
4.5.3 VLAN setting example: .....	43
4.6 QUALITY OF SERVICE .....	49
4.6.1 802.1p Tag Priority Mode .....	50
4.6.2 DSCP QoS Mode .....	52
4.6.3 Port-Based Priority Mode .....	54
4.7 STORM CONTROL .....	55

4.8 MISC CONFIGURATION.....	56
4.9 PoE CONFIGURATION .....	58
4.10 LOGOUT.....	60
<b>5. SWITCH OPERATION.....</b>	<b>61</b>
5.1 ADDRESS TABLE .....	61
5.2 LEARNING .....	61
5.3 FORWARDING & FILTERING .....	61
5.4 STORE-AND-FORWARD.....	61
5.5 AUTO-NEGOTIATION .....	61
<b>6. POWER OVER ETHERNET OVERVIEW.....</b>	<b>62</b>
<b>7. THE POE PROVISION PROCESS.....</b>	<b>64</b>
7.1 LINE DETECTION .....	64
7.2 CLASSIFICATION.....	64
7.3 START-UP.....	65
7.4 OPERATION.....	65
7.5 POWER DISCONNECTION SCENARIOS.....	65
<b>8.TROUBLESHOOTING.....</b>	<b>66</b>
<b>APPENDIX A NETWORKING CONNECTION .....</b>	<b>67</b>
A.1 DATA OUT PoE SWITCH RJ-45 PORT PIN ASSIGNMENTS (PORT 1 TO PORT-4).....	67
A.2 SWITCH'S RJ-45 PIN ASSIGNMENTS (PORT-5 TO PORT-8).....	67
A.3 RJ-45 CABLE PIN ASSIGNMENT .....	67
<b>APPENDIX B .....</b>	<b>69</b>
B.1 POWER OVER ETHERNET COMPATIBILITY TEST .....	69

# 1. INTRODUCTION

## 1.1 Checklist

Check the contents of your package for following parts:

- STW-8P4 x1
- User's manual CD x1
- Quick installation guide x1
- Power cord x 1
- Rubber feet x 4

If any of these pieces are missing or damaged, please contact your dealer immediately, if possible, retain the carton including the original packing material, and use them against to repack the product in case there is a need to return it to us for repair.

## 1.2 About the Switch

The STW-8P4 is equipped with unshielded twisted-pair (UTP) cable ports providing dedicated 10 or 100Mbps bandwidth. The STW-8P4 supports MDI/ MDI-X convertible on 8-10/100Mbps ports, also provide PoE inject function on port#1, 2, 3, 4, which is able to drive 4 IEEE 802.3af compliant powered devices. The dual speed ports use standard twisted-pair cabling and are ideal for SOHO or segmenting networks into small. Each 10/100Mbps port can supports up to 200Mbps of throughput in full-duplex mode, the STW-8P4 also provides a simple, cost-effective, and highly reliable network connection for data as well as power. Furthermore, it is the ideal device for bridging among Ethernet, Fast Ethernet workgroups and networks.

With 4 PoE interfaces, the STW-8P4 is ideal for small business and workgroups requiring to deploy the PoE for the wireless access points, IP-based surveillance camera or IP phones in any places easily, efficiently and cost effective.

The front panel of STW-8P4 provides LEDs for easy recognition of the switch operation status and troubleshooting. These LED indicators display the power status for the system, LNK/ACT and speed for each 10/100M port. Also the PoE in use LED indicates for PoE ports (port#1 to port#4).

With data and power over Ethernet from one unit, the STW-8P4 shall reduce cables and eliminates the need for dedicated electrical outlets on the wall, ceiling or any unreachable place. A wire carries both data and power lowering the installation costs, simplifying the installation effort and eliminating the need for electricians or extension cords. We are also proud of the key feature – energy saving. With more efficient switching power supply, the efficiency of the STW-8P4 would be much better than four linear power adapters in a long run.

The smart functions make it easy to survey and control the PoE power provision to the devices by the Web interface. Basic switching functions such as VLAN, bandwidth control and QoS are available for network management.

## 1.3 Features

- **Interface**
  - 8-Port 10/100Mbps Fast Ethernet ports
  - 4-Port support 48VDC power to PoE Powered Device
  
- **PoE**
  - Complies with IEEE 802.3af Power over Ethernet End-Span PSE
  - Up to 4 IEEE 802.3af devices powered
  - Support PoE Power up to 15.4 watts for each PoE ports
  - Auto detect powered device (PD)
  - Circuit protection prevent power interference between ports

- Remote power feeding up to 100m

- **PoE Management**

- Total PoE power budget control
- Pert port PoE function enable/disable
- PoE Port Power feeding priority
- Per PoE port power limit
- PD classification detection

- **Management**

- Web interface for remote management
- Firmware upgrade through Web interface
- BEWARD Smart Discovery utility automatically finds BEWARD devices on the network
- SNMP Trap for alarm notification of events

- **Switching**

- Hardware based 10/100Mbps auto-negotiation
- Flow control for full duplex operation and back pressure for half duplex operation
- Integrates address look-up engine, support 1K absolute MAC addresses
- Automatic address learning and address aging
- Supports Auto MDI/MDI-X function
- VLAN for network segregation

- **Hardware**

- 10-inch desktop size, rack mountable; 1U height
- Reset button for reset to default setting and system reboot
- LED indicators for POE ready and POE activity
- Optional Rack Ear Accessories Kit for 10-inch cabinet (RKE-10A) and 19-inch cabinet (RKE-10B)

- **Standard Compliance**

- IEEE 802.3 10Base-T
- IEEE 802.3u 100Base-TX
- IEEE 802.3af Power over Ethernet
- FCC Part 15 Class A, CE

## 1.4 Specification

<b>Model</b>	<b>STW-8P4</b>
<b>Hardware Specification</b>	
<b>Network Connector</b>	8-Port RJ-45 for 10/100Base-TX
<b>PoE Inject Port</b>	4-Port with PoE injector function, Port-1 to Port-4
<b>LED Display</b>	One power, 1-4 port PoE in-use, LNK/ACT 5-8 port LNK/ACT
<b>Switch Architecture</b>	Store and Forward switch architecture
<b>Switch Fabric</b>	1.6Gbps
<b>MAC Address</b>	1K MAC address table with Auto learning function
<b>Throughput</b>	1.19Mbps
<b>Remote power feeding</b>	End-point insert type and compatible with IEEE 802.3af Per port feeding power: 48V DC, 15.4W, 350mA (Maximum) (Pin 1, 2, 3, 6)
<b>Power</b>	AC 100~240V, 50/60Hz,
<b>Power Consumption</b>	Max. 65 watts / 221 BTU
<b>Dimension (W x D x H)</b>	217 x 135 x 43 mm
<b>Weight</b>	1.0 kg
<b>Power over Ethernet</b>	
<b>PoE Standard</b>	IEEE 802.3af Power over Ethernet / PSE
<b>PoE Power Supply Type</b>	End-Span
<b>PoE Power Output</b>	Per Port 48V DC, 350mA . Max. 15.4 watts
<b>Power Pin Assignment</b>	1/2(+), 3/6(-)
<b>Power Budget</b>	55 watts
<b>Layer 2 Function</b>	
<b>Management</b>	Web management, SNMP Trap
<b>VLAN</b>	Port-Based VLAN and IEEE 802.1Q Tag-Based VLAN, up to 16 VLAN groups
<b>QoS</b>	2 priority queues for three type of Class of Service <ul style="list-style-type: none"> <li>• Port-Based</li> <li>• IEEE 802.1p priority tag</li> <li>• TCP/IP header's DSCP classifier</li> </ul> Weighted Round Robin queue scheduling
<b>Bandwidth Control</b>	Inbound Rate Limit and Outbound Traffic shaping
<b>Storm Control</b>	Disable, 12.5%, 25%, 50%, 62.5% 4 levels
<b>Standard Conformance</b>	
<b>EMI Safety</b>	FCC Class A, CE
<b>Operating environment</b>	0~40 degree C, 10%~95%RH
<b>Storage environment</b>	-40 ~70 degree C, 95% RH

<b>Operating Humidity</b>	5% to 90% , relative humidity, non-condensing	
<b>Storage Humidity</b>	5% to 90% , relative humidity, non-condensing	
<b>Standard Compliance</b>	IEEE 802.3	Ethernet
	IEEE 802.3u	Fast Ethernet
	IEEE 802.3x	Flow Control
	IEEE 802.3af	Power over Ethernet
	IEEE 802.1p	Class of Service
	IEEE 802.1Q	VLAN Tagging



## 2. HARDWARE DESCRIPTION

This product provides two different running speeds – 10Mbps, 100Mbps in the same Switch and automatically distinguishes the speed of incoming connection.

This section describes the hardware features of STW-8P4. For easier management and control of the Switch, familiarize yourself with its display indicators, and ports. Front panel illustrations in this chapter display the unit LED indicators. Before connecting any network device to the STW-8P4, read this chapter carefully.

In the following section, the term “**PoE Switch**” means the Web Smart PoE switch device, ie. STW-8P4; term of “**switch**” can be any third switches.

### 2.1 Front Panel

The Front Panel of the STW-8P4 PoE Web Smart Ethernet Switch consists of 8x Auto-Sensing 10/100Mbps Ethernet RJ-45 Ports. The LED Indicators are also located on the front panel of the STW-8P4.

#### ■ Front Panel of STW-8P4 ( Hardware version 3)



Figure 2-1 STW-8P4 Switch front panel

#### ■ Reset Button

At the left of front panel, the reset button is designed for reboot the PoE Switch without turn off and on the power.

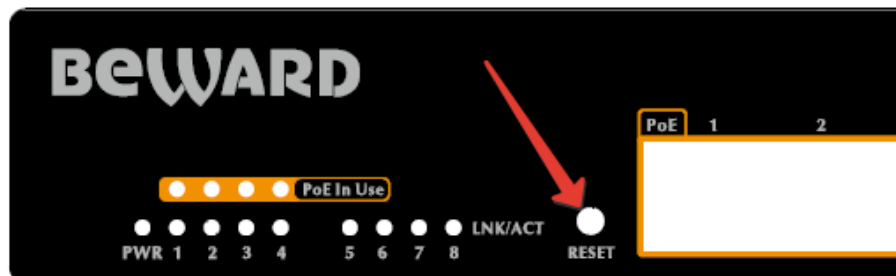

Figure 2-2 Reset button of STW-8P4



Note

To press the RESET button about 10 seconds and then release. The PoE Switch will back to the factory default mode. Be sure that you backup the current configuration of PoE Switch; else the entire configuration will be erased when pressing the “**RESET**” button.

The following is the summary table of Reset button functions:

Reset Button Pressed and Released	Function
About <b>1 second</b>	Reboot the PoE Injector Hub
Until the <b>SYS LED lit off</b>	Reset the PoE Switch to Factory Default configuration. The PoE Switch will reboot and load the default IP settings as below: <ul style="list-style-type: none"> <li>◦ Default Password: <b>admin</b></li> <li>◦ Default IP address: <b>192.168.0.100</b></li> <li>◦ Subnet mask: <b>255.255.255.0</b></li> <li>◦ Default Gateway: <b>192.168.0.254</b></li> </ul>

### 2.1.1 LED indicators

#### ■ System

LED	Color	Function
PWR	Green	Lights to indicate that the PoE Switch has power.

#### ■ Per 10/100Mbps port

LED	Color	Function
PoE in-use	Green	Lights to indicate the port is providing 48VDC in-line power. (1-4 ports)
LNK/ACT	Green	Lit: indicate the link through that port is successfully established. Blinks to indicate that the Switch is actively sending or receiving data over that port.



1. Press the RESET button once. The Switch will reboot automatically.
2. Press the RESET button for 5 seconds. The Switch will back to the factory default mode; the entire configuration will be erased.

### 2.2 Rear Panel

The rear panel of the STW-8P4 indicates an AC inlet power socket, which accepts input power from 100 to 240VAC, 50-60Hz. And have a fan hole on the rear panel.

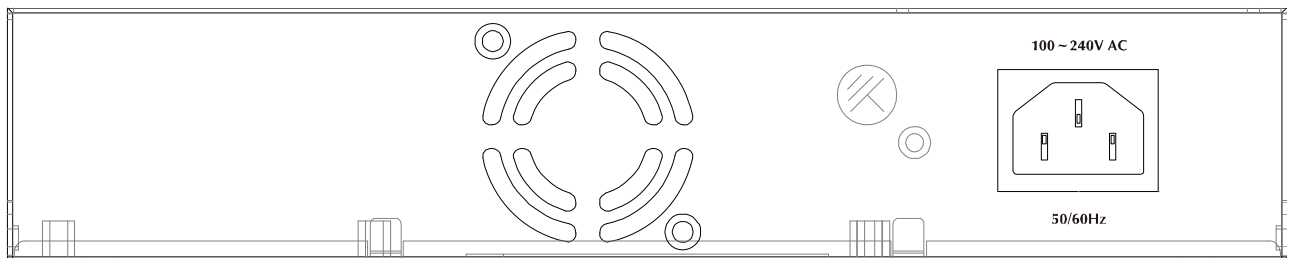

Figure 2-3 STW-8P4 Switch rear panel

#### Power Notice:

1. The device is a power-required device, it means, it will not work till it is powered. If your networks should active all the time, please consider using UPS (Uninterrupted Power Supply) for your device. It will prevent you from network data loss or network downtime.
2. In some area, installing a surge suppression device may also help to protect your STW-8P4 from being damaged by unregulated surge or current to the STW-8P4 or the power adapter.

## 2.3 Hardware Installation

### 2.3.1 Before start up

Before your installation, please refer to the followings for your cabling:

#### ■ 100Base-TX

All 100Base-TX ports come with Auto-Negotiation capability. They automatically support 100Base-TX and 10Base-T networks. Users only need to plug a working network device into one of the 100Base-TX ports, and then turn on the STW-8P4. The port will automatically runs in 10Mbps, 20Mbps, 100Mbps or 200Mbps after the negotiation with the connected device.

#### ■ Cabling

Each 10/100Base-TX ports use RJ-45 sockets -- similar to phone jacks -- for connection of unshielded twisted-pair cable (UTP). The IEEE 802.3u Fast Ethernet standard requires Category 5 UTP for 100Mbps 100Base-TX. 10Base-T networks can use Cat.3, 4, or 5 UTP (see table below). Maximum distance is 100meters (328 feet).

Port Type	Cable Type	Connector
10Base-T	Cat 3, 4, 5, 2-pair	RJ-45
100Base-TX	Cat.5 UTP, 2-pair	RJ-45

Any Ethernet devices like hubs/ PCs can connect to the STW-8P4 by using straight-through wires. The eight-10/100Mbps ports are auto-MDI/MDI-X can be used on straight-through or crossover cable.

## 2.4 Desktop Installation

To install the Switch on desktop, simply follow the next steps:

**Step1:** Attach the rubber feet to the recessed areas on the bottom of the Switch, as shown in Figure 2-4.

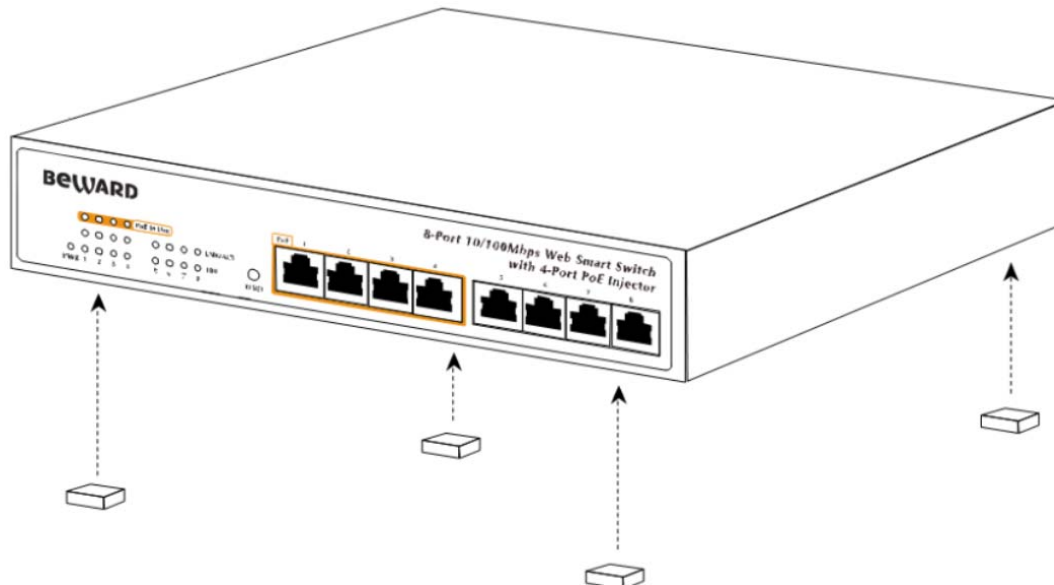

Figure 2-4 Attaching the rubber feet to the Switch

**Step2:** Place the Switch on desktop near an AC power source.

**Step3:** Keep enough ventilation space between the Switch and the surrounding objects.



When choosing a location, please keep in mind the environmental restrictions discussed in Chapter 1, Section 4, in Specification.

**Step4:** Connect your Switch to network devices.

- A. Connect one end of a standard network cable to the 10/100 RJ-45 ports on the Back of the Switch.
- B. Connect the other end of the cable to the network devices such as printer servers, workstations or routers...etc.



Connection to the Switch requires UTP Category 5 network cabling with RJ-45 tips. For more information, please see the Cabling Specification in Appendix A.

**Step5:** Supply power to the Switch.

- A. Connect one end of the power cable to the Switch.
- B. Connect the power plug of the power cable to a standard wall outlet.

When the Switch receives power, the Power LED should remain solid Green.

## 2.5 Rack Mounting (Optional Rack Kits)

To install the Switch in a 10-inch or 19-inch standard rack, BEWARD provides the optional rack mount kits **RKE-10A** / **RKE-10B** for different need. Follow the instructions described below.

**Step1:** Place your Switch on a hard flat surface, with the front panel positioned towards your front side.

**Step2:** Attach a rack-mount bracket to each side of the Switch with supplied screws attached to the package. [Figure 2-5](#) shows how to attach brackets to one side of the Switch.

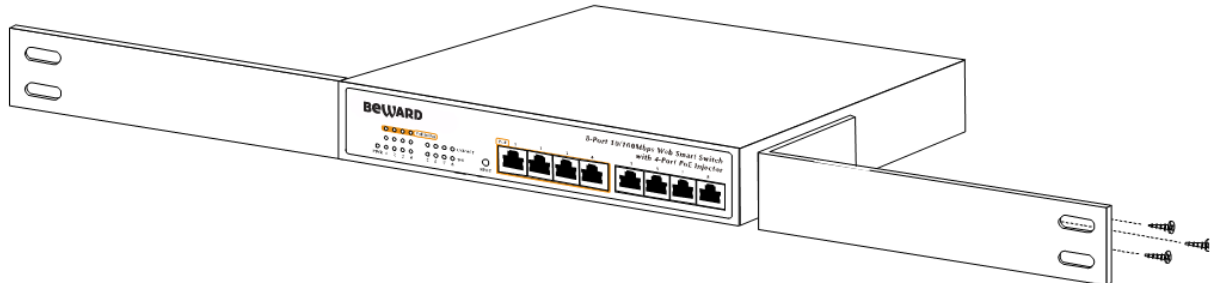

**Figure 2-5** Attaching the brackets to the Switch.



You must use the screws supplied with the mounting brackets. Damage caused to the parts by using incorrect screws would invalidate the warranty.

**Step3:** Secure the brackets tightly.

**Step4:** Follow the same steps to attach the second bracket to the opposite side.

**Step5:** After the brackets are attached to the Switch, use suitable screws to securely attach the brackets to the rack, as shown in [Figure 2-6](#).

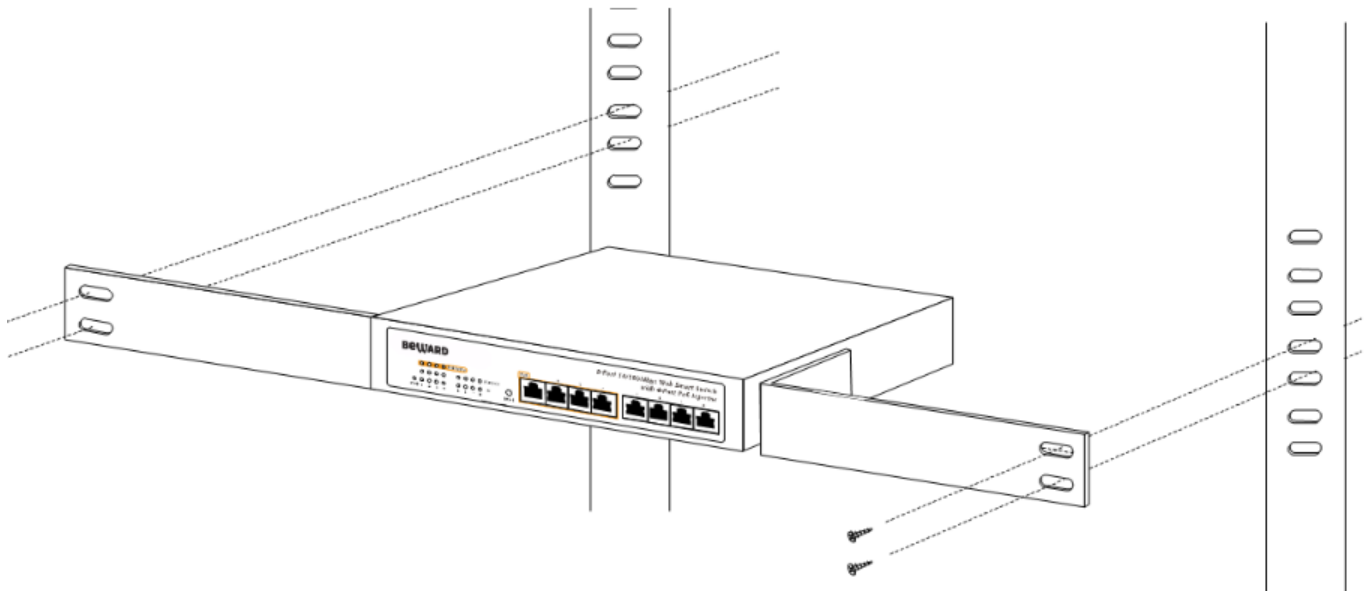

**Figure 2-6** Mounting the Switch in a Rack

**Step6:** Proceeds with the steps 4 and steps 5 of **session 2.4 Desktop Installation** to connect the network cabling and supply power to your Switch.

## 2.6 Product Application

### 2.6.1 Connecting end node or Switch

1. Place the STW-8P4 on a smooth surface or fasten the mounting brackets purchased separately with the provided screws in a standard 19" rack.
2. Connect the power cord to the power inlet socket of STW-8P4 and the other end into the local power source outlet. When the Switch receives power, the Power LED should remain solid Green.
3. Connect other switch or PC to one port of the STW-8P4 using Category 3/4/5 UTP/STP cabling.
4. Connect another switch or PC to the other port of STW-8P4 by following the same process as described in Step 3.

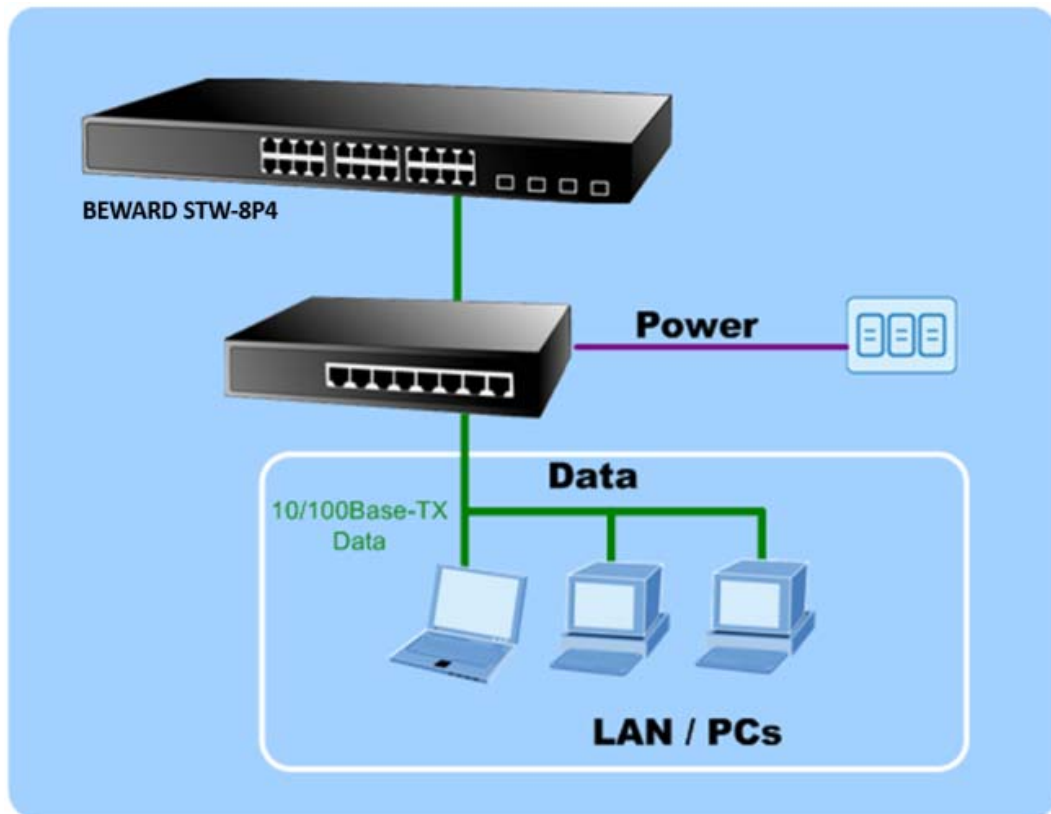

Figure 2-7 End node or Switch connection

#### Cable distance for Switch

The cable distance between the STW-8P4 and PC should not exceed 100 meter for UTP/STP cable.



#### Make sure the wiring is correct

It can be used Category 3/4/5 cable in 10 Mbps operation. To reliably operate your network at 100Mbps, you must use an Unshielded Twisted-Pair (UTP) Category 5 cable, or better Data Grade cabling. While a Category 3 or 4 cables may initially seem to work, it will soon cause data loss.

**2.6.2 As a department / workgroup PoE Switch**

Providing up to 4 PoE, in-line power interface, the Switch can easily build a power central-controlled IP phone system, IP Camera system, AP group for the enterprise. For instance, 4 camera / AP can be easily installed around the corner in the company for surveillance demands or build a wireless roaming environment in the office. Without the power-socket limitation, the switch makes the installation of cameras or WLAN AP more easily and efficiently.

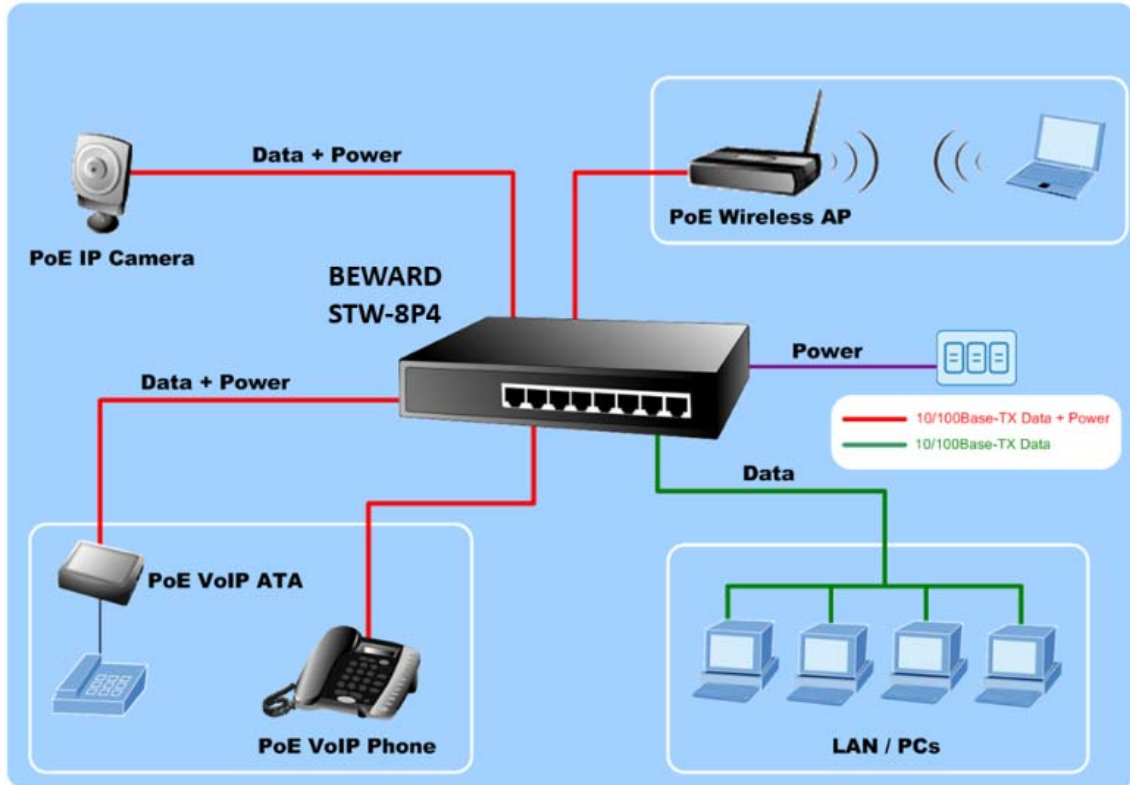





Figure 2-8 PoE Switch connection

**2.7 Power over Ethernet Powered Device**

 <b>3-5 watts</b>	<p><b>Voice over IP phones</b>                  Enterprise can install POE VoIP Phone, ATA and other Ethernet/non-Ethernet end-devices to the central where UPS is installed for un-interrupt power system and power control system.</p>
 <b>6-12 watts</b>	<p><b>Wireless LAN Access Points</b>                  Museum, Sightseeing, Airport, Hotel, Campus, Factory, Warehouse can install the Access Point any where with no hesitation</p>
 <b>10-12 watts</b>	<p><b>IP Surveillance</b>                  Enterprise, Museum, Campus, Hospital, Bank, can install IP Camera without limits of install location – no need electrician to install AC sockets.</p>
 <b>3-12 watts</b>	<p><b>PoE Splitter</b>                  PoE Splitter split the PoE 48V DC over the Ethernet cable into 5/9/12V DC power output. It frees the device deployment from restrictions due to power outlet locations, which eliminate the costs for additional AC wiring and reduces the installation time.</p>

## 3 MANAGEMENT

This chapter describes how to manage the PoE Switch. Topics include:

- Overview
- Management method
- Logging on to the Web Smart Switch

### 3.1 Overview

The Web Smart PoE Switch provides a user-friendly, Web interface. Using this interface, you can perform various device configuration and management activities, including:

- System
- Power over Ethernet
- Tools

### 3.2 Requirements

- Network cables.  
Use standard network (UTP) cables with RJ45 connectors.
- Subscriber PC installed with Ethernet NIC (Network Card)
- Workstations of subscribers running Windows 98/ME, NT4.0, 2000/2003/XP, MAC OS X or later, Linux, UNIX or other platform compatible with TCP/IP protocols.
- Above PC installed with WEB Browser and JAVA runtime environment Plug-in



It is recommended to use **Internet Explorer 6.0** or above to access Web Smart Switch.

### 3.3 Management Method

User can manage the PoE Switch by Web Management via a network connection.

#### 3.3.1 Web Management

The PoE Switch can be configured through an Ethernet connection, make sure the manager PC must be set on same the **IP subnet address** with the PoE Switch.

For example, if you have changed the default IP address of the Device to **192.168.99.123** with subnet mask **255.255.255.0** via console, then the manager PC should be set at **192.168.99.x** (where x is a number between 2 and 254) with subnet mask **255.255.255.0**. Or you can use the factory default IP address **192.168.0.100** to do the relative configuration on manager PC.



1. Use Internet Explorer 5.0 or above Web browser. Enter IP address **http://192.168.0.100** (the factory-default IP address or that you have changed via console) to access the Web interface.

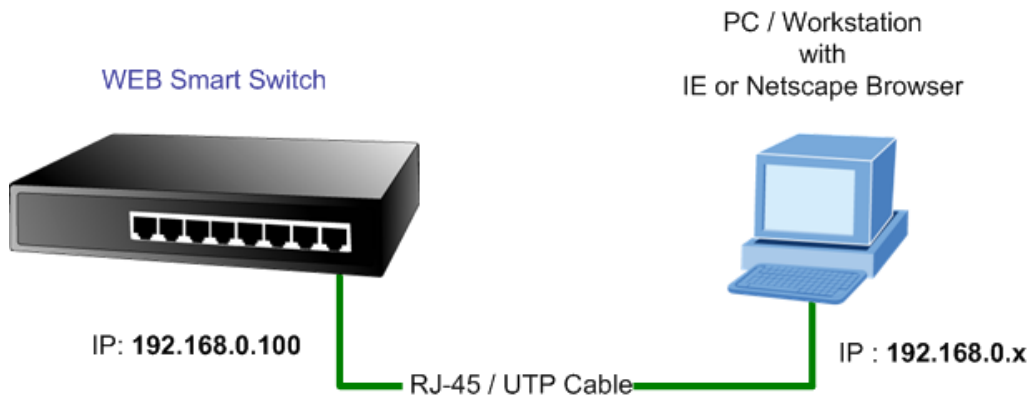

Figure 3-1 Web Management over Ethernet

2. When the following login screen appears, please enter the default username "**admin**" and password "**admin**" (or the password you have changed via console) to login the main screen of PoE Switch. The login screen in Figure 3-2 appears.

Default IP Address: **192.168.0.100**  
 Default Account: **admin**  
 Default Password: **admin**

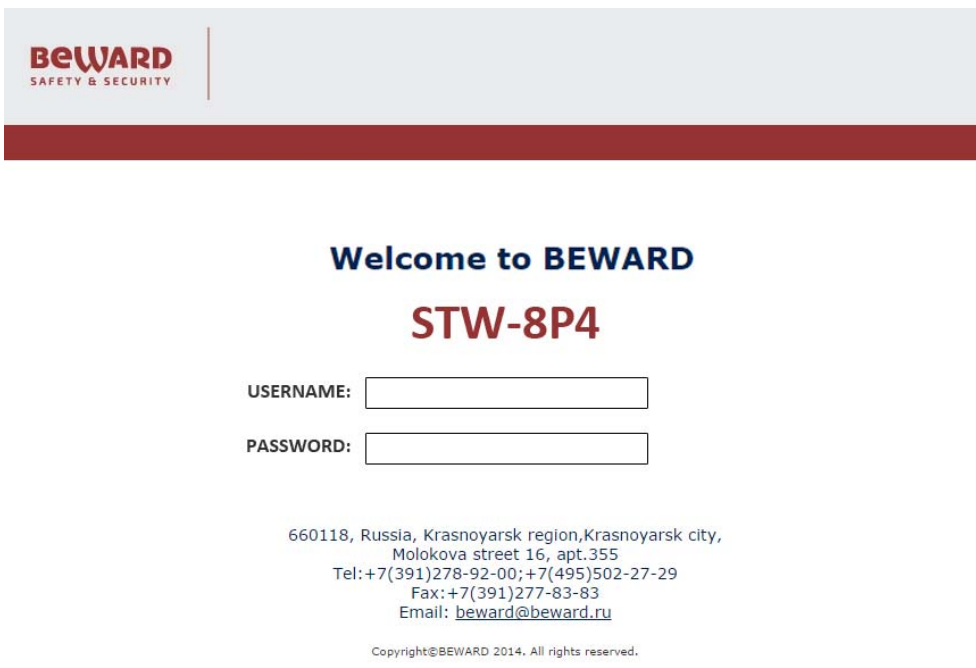

Figure 3-2 Login screen



Note

1. For security reason, please change and memorize the new password after this first setup.
2. Only accept command in lowercase letter under WEB interface.

### 3.3.2 BEWARD Smart Discovery Utility

For easily list the Switch in your Ethernet environment, the BEWARD Smart Discovery Utility from user's manual CD-ROM is an ideal solution.

The following install instructions guiding you for run the BEWARD Smart Discovery Utility.

1. Deposit the BEWARD Smart Discovery Utility in administrator PC.
2. Run this utility and the following screen appears.



Figure 3-3 BEWARD Smart Discovery Utility Screen



If there are two LAN cards or above in the same administrator PC, choose different LAN card by use the "Select Adapter" tool.

3. Press "Refresh" button for list current connected devices in the discovery list, the screen is shown as follow.

4. This utility show all necessary information from the devices, such as MAC Address, Device Name, firmware version, Device IP Subnet address, also can assign new password, IP Subnet address and description for the devices.
5. After setup completed, press “**Update Device**”, “**Update Multi**” or “**Update All**” button to take affect. The meaning of the 3 buttons above are shown as below:

**Update Device:** use current setting on one single device.

**Update Multi:** use current setting on choose multi-devices.

**Update All:** use current setting on whole devices in the list.

The same functions mentioned above also can be finding in “**Option**” tools bar.

6. To click the “**Control Packet Force Broadcast**” function, it can allow assign new setting value to the Switch under different IP subnet address.
7. Press “**Connect to Device**” button then the Web login screen appears in [Figure 3-2](#).
8. Press “**Exit**” button to shutdown the BEWARD Smart Discovery Utility.

## 4. WEB CONFIGURATION

The Switch provide Web interface for PoE smart function configuration and make the Switch operate more effectively - They can be configured through the Web Browser. A network administrator can manage and monitor the Switch from the local LAN. This section indicates how to configure the Switch to enable its smart function.

### 4.1 Main Menu

After a successful login, the main screen appears. The main screen displays the product name the function menu, and the main information in the center. As showed in [Figure 4-1](#).

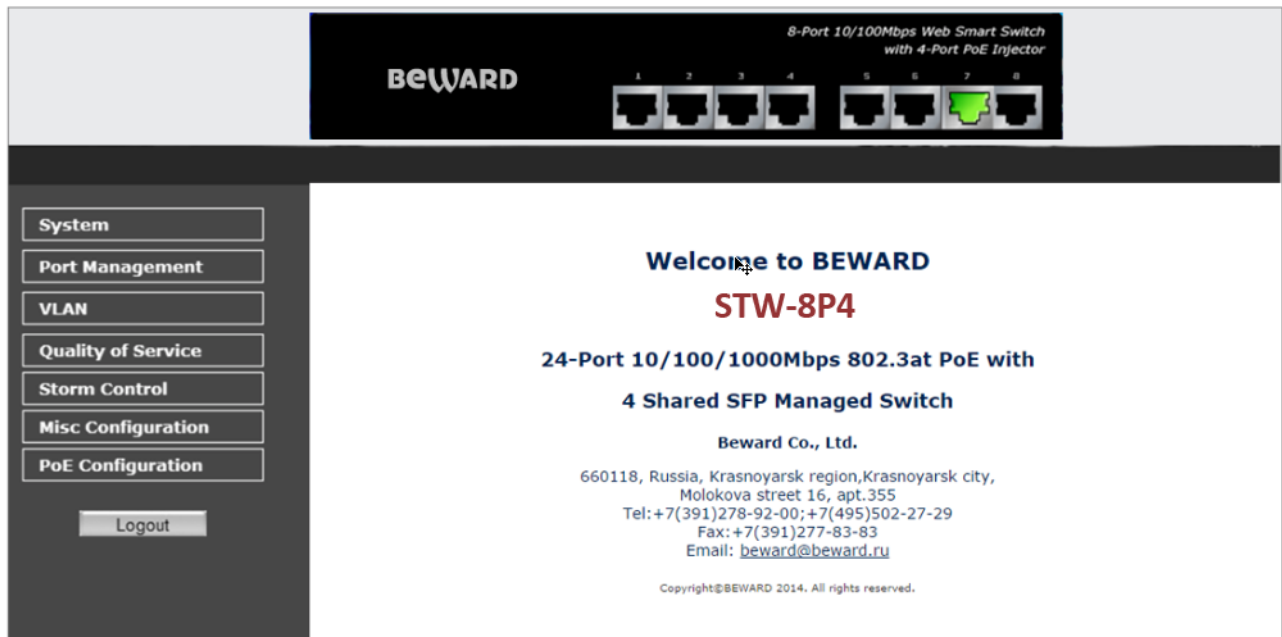

Figure 4-1 main menu screen

The four items and it description shown as below:

- **System:** Provide System information and configuration of Switch. [Explained in section 4.3.](#)
- **Port Management** Setup per port mode, Rate Limit, Port description. [Explained in section 4.4.](#)
- **VLAN** Configure VLAN Member / Port Configuration. [Explained in section 4.5.](#)
- **Quality of Service** Mapping the packet level to classify the packets priority. [Explained in section 4.6.](#)
- **Storm Control** Enable Storm Control function to reduce broadcast packets on the Switch. [Explained in section 4.7.](#)
- **Misc Configuration** Configure MAC address table aging, aging time mode and port flow control. [Explained in section 4.8.](#)
- **PoE Configuration** Provide PoE Management configuration of Switch. [Explained in section 4.9.](#)
- **Logout:** Provide Logout function of Switch.

## 4.2 Web Panel

At the top of the Web management page, the active panel displays the link status of management port and PoE ports.



Figure 4-2 Main menu screen

- Green lit is the port link up.
- Orange lit is the PoE in use.

## 4.3 System

The System function allows viewing system information, IP Configuration and Password Setting. As showed in [Figure 4-3](#).

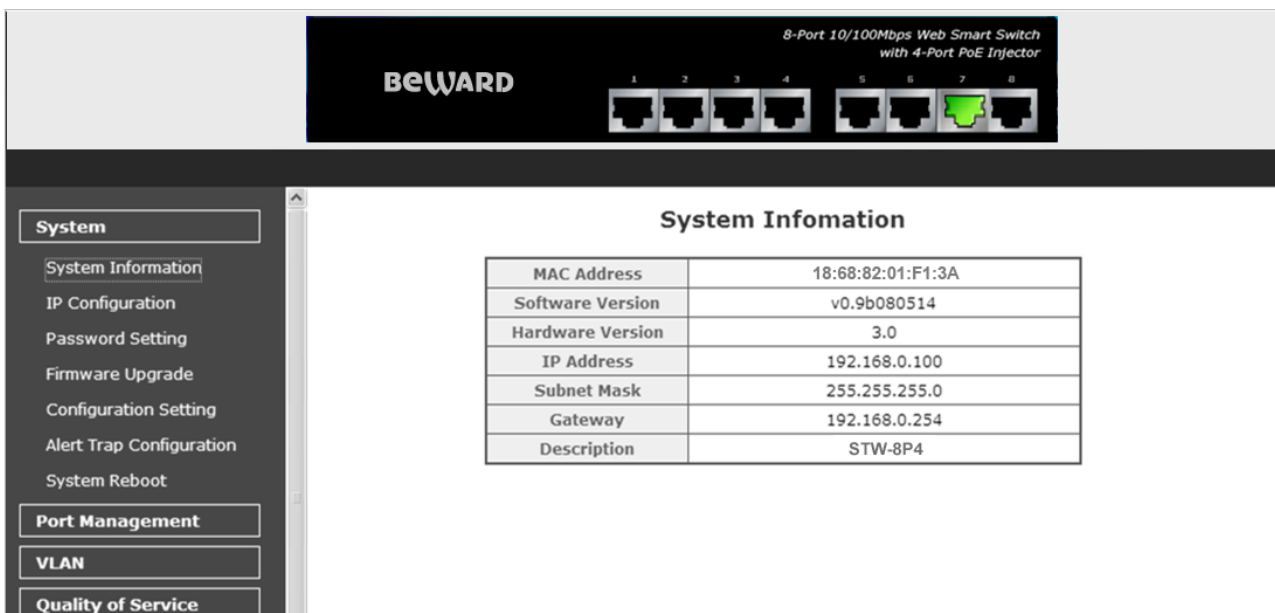

Figure 4-3 System screen

The page includes the following information:

Object	Description
<b>System Information</b>	Display the MAC address, Software Version, Hardware Version, IP address, Subnet Mask and Gateway. <a href="#">Explained in section 4.3.1.</a>
<b>IP Configuration</b>	Allow to change the IP subnet address of Switch. <a href="#">Explained in section 4.3.2.</a>
<b>Password Setting</b>	Allow to change the username and password of Switch. <a href="#">Explained in section 4.3.3.</a>
<b>Firmware Upgrade</b>	Allow proceed firmware upgrade process of Switch. <a href="#">Explained in section 4.3.4</a>
<b>Configuration Setting</b>	Allow to upload / back configuration of Switch and reset Switch to factory default. Explained in section. <a href="#">Explained in section 4.3.5.</a>
<b>Alert Trap Configuration</b>	Set up SNMP trap receiver's IP address and trap event. <a href="#">Explained in section 4.3.6.</a>
<b>System Reboot</b>	Allow reboot the Switch.

### 4.3.1 System Information

The System information allows viewing system MAC Address, Software Version, Hardware Version, IP Address, Subnet Mask and Gateway. As showed in [Figure 4.4](#)

#### System Infomation

MAC Address	18:68:82:01:F1:3A
Software Version	v0.9b080514
Hardware Version	3.0
IP Address	192.168.0.100
Subnet Mask	255.255.255.0
Gateway	192.168.0.254
Description	STW-8P4

**Figure 4-4** System Information screen

The page includes the following fields:

Object	Description
<b>MAC Address</b>	Specifies the Switch MAC address.
<b>Software Version</b>	The current software version running on the Switch.
<b>Hardware Version</b>	The current hardware version of the Switch.
<b>IP Address</b>	The current IP Address of the Switch.
<b>Subnet Mask</b>	The current IP Subnet Mask value of the Switch.
<b>Gateway</b>	The current Gateway value of the Switch.
<b>Description</b>	The current description of the Switch.

### 4.3.2 IP Configuration

This section provides DHCP Client, change the IP Address, Subnet Mask, Gateway and Description, the screen in [Figure 4-5](#) appears.

#### IP Configuration

DHCP Client	Disable ▾
IP Address	192.168.0.100
Subnet Mask	255.255.255.0
Gateway	192.168.0.254
Description	STW-8P4

Apply

**Figure 4-5** IP Configuration screen

The page includes the following configurable data:

Object	Description
<b>DHCP Client</b>	Choose what the Switch should do following power-up: transmit a DHCP request, or manual setting (Disable).  The DHCP client function only works if you haven't assigned a static IP address that different than the Switch default IP. Once the default IP has been changed the DHCP will not effective and the Switch will continue using the manually entered static IP. If you have changed the Switch to a static IP address, you can set the IP address back to its default IP address or you can reset the Switch back to factory default. And then you can enable the DHCP client function to work.  The factory default is <b>Disable</b> .
<b>IP Address</b>	The IP address of the Switch. The factory default value is <b>192.168.0.100</b> .
<b>Subnet Mask</b>	The IP subnet mask of the Switch. The factory default value is <b>255.255.255.0</b> .
<b>Gateway</b>	The default gateway of the Switch. The factory default value is <b>192.168.0.254</b> .
<b>Description</b>	This field helps to identify the description of Switch.

### 4.3.3 Password Setting

This section provides password change Configuration of STW-8P4, please input the old password in “**Old Password**” space and input the new password in “**New Password**” space then input the new password in “**Confirm**”. After setup completed, please press “**Apply**” button to take effect and the Switch will logout automatically. Please login web interface with new password, the screen in [Figure 4.6](#) appears.

**Password Setting**

Login Name	<input type="text" value="admin"/>
Old Password	<input type="text"/>
New Password	<input type="text"/>
Confirm	<input type="text"/>

**Figure 4-6** Password Setting screen

The page includes the following configurable data:

Object	Description
<b>Login Name</b>	Displays the login user name.
<b>Old Password</b>	Enter the old password is required before entering the new password.
<b>New Password</b>	Specifies the new password. The password is not displayed. As it entered an "*" corresponding to each character is displayed in the field.  (The maximum length is 16 characters)
<b>Confirm</b>	This confirms the new password. The password entered into this field must be exactly the same as the password entered in the Password field.

#### 4.3.4 Firmware Upgrade

This section provides firmware upgrade of PoE Switch, after choose this function and the following screen appears in [Figure 4-7](#). Please press "Update" button to continue following firmware upgrade process.



**Figure 4-7** Firmware Upgrade screen

Please wait for two seconds and the page will show to next firmware upgrade web page, the screen in [Figure 4-8](#) appears.

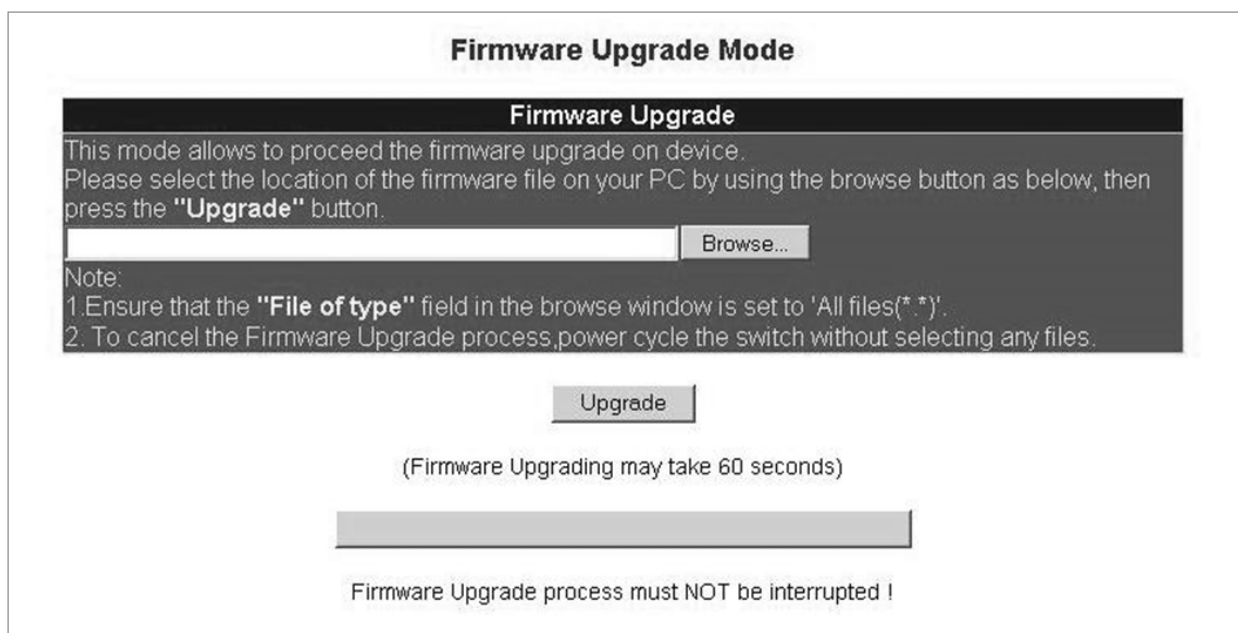

**Figure 4-8** Firmware Upgrade screen



Please press “**Browser**” to locate the latest firmware of Switch that deposit in your PC and press “**Upgrade**” to start the firmware upgrade process. The screen in [Figure 4-9](#) appears.

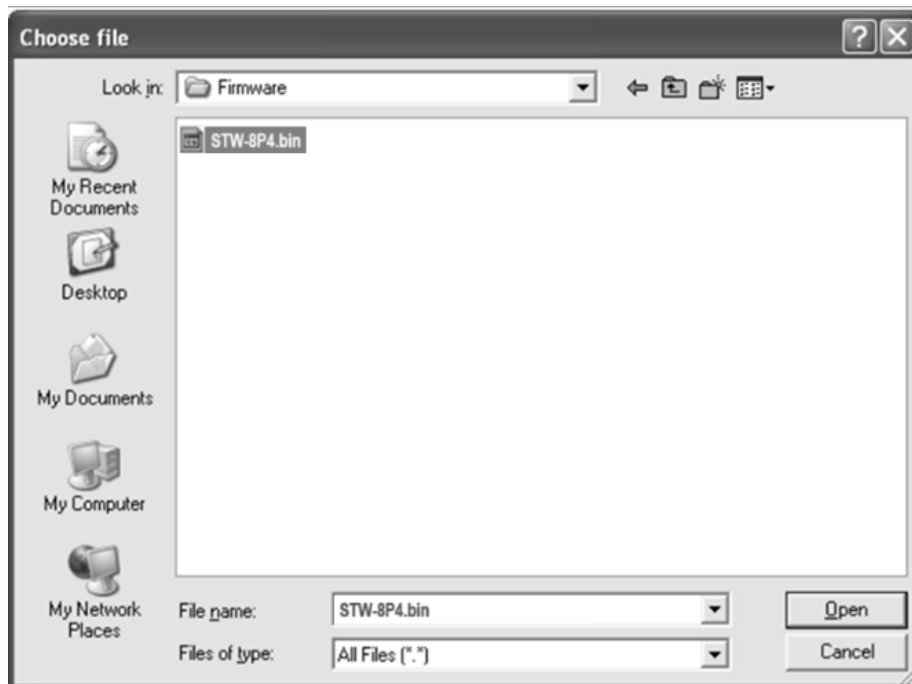

**Figure 4-9** Firmware Upgrade screen



1. Do not **power off** the PoE Switch until the update progress is complete.
2. Do not **quit** the Firmware Upgrade page without press the “**Upgrade**” button - after the image is loaded. Or the system won't apply the new firmware. Users have to repeat the firmware upgrade processes again.



**Do not use Firefox or Windows Vista** platform for STW-8P4 firmware upgrade or it might cause the firmware upgrade fail. It is due to the short “HTTP respond time” for Firefox and Windows Vista. While firmware upgrade, there is no immediately respond each to the Firefox and Windows Vista, they will break the connection as http time out. It is suggested to use the Microsoft IE 6.0 at Windows XP platform for firmware upgrade.

### 4.3.5 Configuration Setting

This function allows backup and restore the current configuration of PoE Switch, or reset the converter to factory default. The description of the three items as follow and screen in [Figure 4-10](#) appears.

- **Backup** - To backup/save the current configuration to the storage block on this converter.
- **Restore** – To restore the previous backup configuration from the storage block.
- **Factory** – To reset the Injector Hub back to the factory default mode.

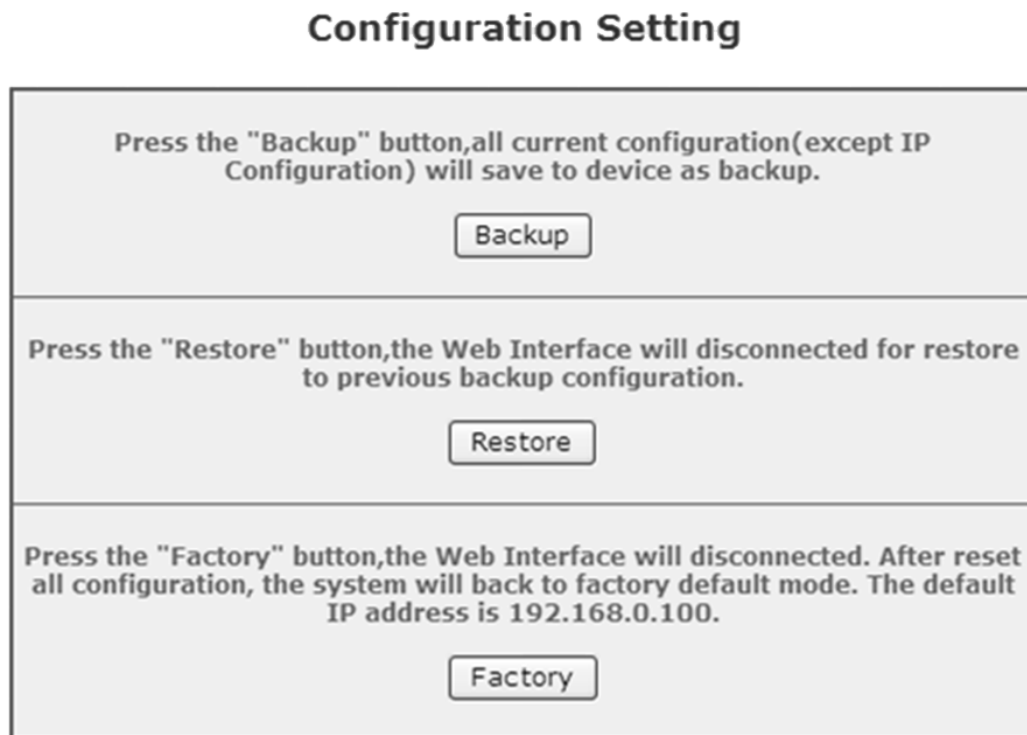

Figure 4-10 Configuration Setting screen

#### ■ Backup

All current configurations (except IP Configuration) will save to converter as backup once the "**Backup**" button is pressed.

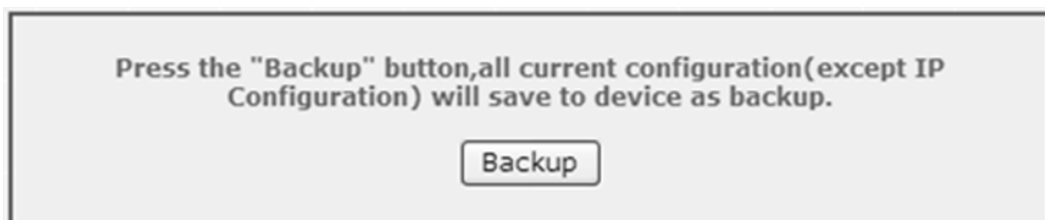

Figure 4-11 Configuration Setting\Backup screen

After the "**Backup**" button is pressed and success backup current configuration, the screen in [Figure 4-12](#) appears

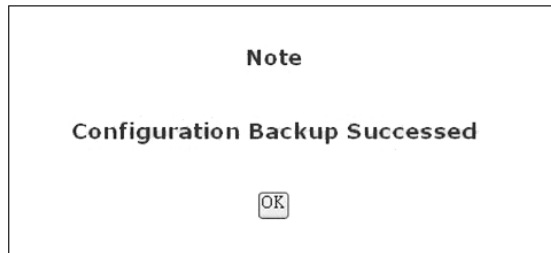

Figure 4-12 Configuration backup successes screen

## ■ Restore

The PoE Switch will restore to previous backup/saved configuration while the **"Restore"** button be pressed. And please note that once the Restore button be pressed, Web interface will disconnected for a while. Reload the Web browser to re-login the system.



Figure 4-13 Configuration restore screen

## ■ Factory Reset

The **Factory** Reset button can reset the PoE Switch back to the factory default mode. Be aware that the entire configuration will be reset, and the IP address of the Switch will be set to **"192.168.0.100"**.



Figure 4-14 Factory Reset screen

Once the Factory Reset item is pressed, the screen in [Figure 4-15](#) appears.



Figure 4-15 Factory Reset screen

### 4.3.6 Alert Trap Configuration

This function displays the Switch alert trap configuration; include “enable” or “disable” the trap mode and set the alert IP address. As showed in [Figure 4-16](#).

**Alert Trap Configuration**

Trap mode	Enable
Alert IP Address	192.168.0.166
Trap Event	Enable
Cold start	<input checked="" type="checkbox"/>
Login Fail	<input checked="" type="checkbox"/>
Password changed	<input checked="" type="checkbox"/>
IP changed	<input checked="" type="checkbox"/>
PoE Alert	<input checked="" type="checkbox"/>

**Figure 4.16** Alert Trap Configuration screen

Object	Description
<b>Trap mode</b>	Can choose enable/disable to get the trap
<b>Alert IP address</b>	Assign one IP address of host to receive SNMP trap from the device.
<b>Trap event</b>	Can choose which event can send the SNMP trap. The trap events include: <ul style="list-style-type: none"> <li><input type="checkbox"/> Cold Star</li> <li><input type="checkbox"/> Login Fail</li> <li><input type="checkbox"/> Password changed</li> <li><input type="checkbox"/> IP Changed</li> <li><input type="checkbox"/> PoE Alert</li> </ul>

#### PoE SNMP Trap event

- **PoE Port On** PoE port is supplying the power to the PD
- **PoE AC Disconnect Port Off** PoE port was turned off, due to AC Disconnect function
- **PoE DC Disconnect Port Off** PoE port was turned off, due to DC Disconnect function
- **PoE Overload Port Off** PoE port off due to overload event
- **PoE Short Circuit Port Off** PoE port off due to short circuit event

### 4.3.7 System Reboot

This section provides reboot STW-8P4, after choose this function and the following screen appears in Figure 4-17. Please press “OK” button to take effect and the PoE Switch will reboot and ask you to re-login web interface with correct user-name “admin” and password, the screen in Figure 4-18 & 4-19 appears.



Figure 4-17 reboot system Web Page screen



Figure 4-18 rebooting Web Page screen



## Welcome to BEWARD

### STW-8P4

USERNAME:

PASSWORD:

660118, Russia, Krasnoyarsk region, Krasnoyarsk city,  
Molokova street 16, apt.355  
Tel: +7(391)278-92-00; +7(495)502-27-29  
Fax: +7(391)277-83-83  
Email: [beward@beward.ru](mailto:beward@beward.ru)

Copyright©BEWARD 2014. All rights reserved.

Figure 4-19 login Web Page screen

## 4.4 Port Management

In this chapter, there are three sub-functions can be configure and monitor about network interfaces:

- Port Configuration
- Port Status
- Port Security

### 4.4.1 Port Configuration

This section introduces detail settings of per port of STW-8P4, the screen in [Figure 4-20](#) appears and table 4-2 descriptions the Port Setup objects of PoE Switch.

### Port Configuration

Port	Link	Mode	Ingress Rate Limit	Egress Shaping	Description
Port1	Auto	Auto Speed ▾	No Limit ▾	No Limit ▾	<input type="text"/>
Port2	Auto	Auto Speed ▾	No Limit ▾	No Limit ▾	<input type="text"/>
Port3	Auto	Auto Speed ▾	No Limit ▾	No Limit ▾	<input type="text"/>
Port4	Auto	Auto Speed ▾	No Limit ▾	No Limit ▾	<input type="text"/>
Port5	Auto	Auto Speed ▾	No Limit ▾	No Limit ▾	<input type="text"/>
Port6	Auto	Auto Speed ▾	No Limit ▾	No Limit ▾	<input type="text"/>
Port7	Auto	Auto Speed ▾	No Limit ▾	No Limit ▾	<input type="text"/>
Port8	Auto	Auto Speed ▾	No Limit ▾	No Limit ▾	<input type="text"/>

**Figure 4-20** Port Setup Web Page screen

The page includes the following configurable data:

Object	Description
<b>Port</b>	Indicate port 1 to port 8.
<b>Link</b>	Display the current Port link status
<b>Mode</b>	<p>Allow configuration the port speed and operation mode. Draw the menu bar to select the mode.</p> <ul style="list-style-type: none"> <li>• <b>Auto Speed</b> - Setup Auto negotiation</li> <li>• <b>10 Half</b> - Force sets 10Mbps/Half-Duplex mode</li> <li>• <b>10 Full</b> - Force sets 10Mbps/Full-Duplex mode</li> <li>• <b>100 Half</b> - Force sets 100Mbps/Half-Duplex mode</li> </ul>

	<ul style="list-style-type: none"> <li>• <b>100 Full</b> - Force sets 100Mbps/Full-Duplex mode</li> <li>• <b>Disable</b> - Shutdown the port manually</li> </ul> <p>Default: <b>Auto Speed</b></p>
<b>Ingress Rate Limit</b>	<p>The value of inbound traffic limitation in kilobit-per-second (kbps). Default : <b>No Limit</b></p> <ul style="list-style-type: none"> <li>• <b>No Limit</b></li> <li>• <b>128K</b></li> <li>• <b>256K</b></li> <li>• <b>512K</b></li> <li>• <b>1M</b></li> <li>• <b>2M</b></li> <li>• <b>4M</b></li> <li>• <b>8M</b></li> </ul>
<b>Egress Shaping</b>	<p>The value of outbound traffic limitation in kilobit-per-second (kbps). Default : <b>No Limit</b></p> <ul style="list-style-type: none"> <li>• <b>No Limit</b></li> <li>• <b>128K</b></li> <li>• <b>256K</b></li> <li>• <b>512K</b></li> <li>• <b>1M</b></li> <li>• <b>2M</b></li> <li>• <b>4M</b></li> <li>• <b>8M</b></li> </ul>
<b>Description</b>	<p>Allow to set value for port Description, This column accepts characters —“0-9, A-Z, a-z, @, - _ and * “. Maximum: 8 characters</p>

**Table 4-2** Descriptions of the Port Setup screen Objects



When the ports are being set as fixed 100M Full, 100M Half, 10M Full, and 10M Half-speed modes, the Auto-MDIX function will disable.

Note

### 4.4.2 Port Status

This section provides current status of each port from STW-8P4, the screen in [Figure 4-21](#) appears and Table 4-3 describes the port status object of PoE Switch.

#### Port Status

Port	Auto-Negotiation Ability	Auto-Negotiation Complete	Capability			
			10H	10F	100H	100F
1	On	Off	On	On	On	On
2	On	Off	On	On	On	On
3	On	Off	On	On	On	On
4	On	Off	On	On	On	On
5	On	Off	On	On	On	On
6	On	Off	On	On	On	On
7	On	On	On	On	On	On
8	On	Off	On	On	On	On

**Link partner ability**

Port	Pause	Capability			
		10H	10F	100H	100F
1	Off	Off	Off	Off	Off
2	Off	Off	Off	Off	Off
3	Off	Off	Off	Off	Off
4	Off	Off	Off	Off	Off
5	Off	Off	Off	Off	Off
6	Off	Off	Off	Off	Off
7	Off	On	On	On	On
8	Off	On	On	On	On

Refresh

**Figure 4-21** Port Status Web Page screen

Object	Description
<b>Port</b>	Indicate port 1 to port 8.
<b>Link</b>	The state of the link, indicating a valid link partner device. <b>"Up"</b> means a device is successful connected to the port. <b>"Down"</b> means no device is connected.
<b>Speed</b>	Display the <b>10Mbps or 100Mbps</b> speed state of each port on STW-8P4.
<b>Duplex</b>	Display half or full duplex mode of each port on STW-8P4.
<b>Flow Control</b>	Display the flow control <b>Disable or Enable</b> state of each port on STW-8P4.

**Table 4-3** Descriptions of the Port Status screen Objects

**4.4.3 Port Security**

The Layer 2 MAC address learning function can be per-port disable for security management purposes. When the port is in security mode, the port will be "locked" without permission of address learning.

1. Port Security enabled port will record the **first receiving packet's source MAC address** as a **"Security MAC address"**.
2. A security port only allows that packet which has the "Security MAC address" to active on.

**Port Security**

	1	2	3	4	5	6	7	8
Port Security Enable	<input type="checkbox"/>	<input type="checkbox"/>	<input type="checkbox"/>	<input type="checkbox"/>	<input type="checkbox"/>	<input type="checkbox"/>	<input type="checkbox"/>	<input type="checkbox"/>

Apply

**Figure 4-22** Port Security screen



Object	Description
<b>Port</b>	Which selecting this option locks the specified interface.
<b>Port Security Enable</b> <b>Check Box</b>	Enable Source MAC address lock function on specified port. By which locks the port using the classic lock mechanism. The port is immediately locked without permission of address learning.



1. The Device will reboot after enable Port Security.
2. After reboot, each port will record the first receiving packet's source MAC address as a "Security MAC address".
3. A security port only allows that packet which has the "Security MAC address" to active on.

## 4.5 VLAN

A Virtual LAN (VLAN) is a logical network grouping that limits the broadcast domain. It allows you to isolate network traffic so only members of the VLAN receive traffic from the same VLAN members. Basically, creating a VLAN from a switch is logically equivalent of reconnecting a group of network devices to another Layer 2 switch. However, all the network devices are still plug into the same switch physically.

The Ethernet Switch supports 802.1Q (tagged-based) and Port-Base VLAN setting in web management page. In the default configuration, VLAN support is “**IEEE 802.1Q**”.

### Port-based VLAN

Port-based VLAN limit traffic that flows into and out of switch ports. Thus, all devices connected to a port are members of the VLAN(s) the port belongs to, whether there is a single computer directly connected to a switch, or an entire department.

On port-based VLAN, NIC do not need to be able to identify 802.1Q tags in packet headers. NIC send and receive normal Ethernet packets. If the packet's destination lies on the same segment, communications take place using normal Ethernet protocols. Even though this is always the case, when the destination for a packet lies on another switch port, VLAN considerations come into play to decide if the packet is dropped by the Switch or delivered.

### IEEE 802.1Q VLANs

IEEE 802.1Q (tagged) VLAN are implemented on the Switch. 802.1Q VLAN require tagging, which enables them to span the entire network (assuming all switches on the network are IEEE 802.1Q-compliant).

VLAN allow a network to be segmented in order to reduce the size of broadcast domains. All packets entering a VLAN will only be forwarded to the stations (over IEEE 802.1Q enabled switches) that are members of that VLAN, and this includes broadcast, multicast and unicast packets from unknown sources.

VLAN can also provide a level of security to your network. IEEE 802.1Q VLAN will only deliver packets between stations that are members of the VLAN. Any port can be configured as either tagging or untagging. The untagging feature of IEEE 802.1Q VLAN allows VLAN to work with legacy switches that don't recognize VLAN tags in packet headers. The tagging feature allows VLAN to span multiple 802.1Q-compliant switches through a single physical connection and allows Spanning Tree to be enabled on all ports and work normally.

Any port can be configured as either tagging or untagging. The untagging feature of IEEE 802.1Q VLAN allows VLAN to work with legacy switches that don't recognize VLAN tags in packet headers. The tagging feature allows VLAN to span multiple 802.1Q-compliant switches through a single physical connection and allows Spanning Tree to be enabled on all ports and work normally.

Some relevant terms:

**Tagging** - The act of putting 802.1Q VLAN information into the header of a packet.

**Untagging** - The act of stripping 802.1Q VLAN information out of the packet header.

**802.1Q VLAN Tags**

The figure below shows the 802.1Q VLAN tag. There are four additional octets inserted after the source MAC address. Their presence is indicated by a value of **0x8100** in the Ether Type field. When a packet's Ether Type field is equal to 0x8100, the packet carries the IEEE 802.1Q/802.1p tag. The tag is contained in the following two octets and consists of 3 bits of user priority, 1 bit of Canonical Format Identifier (CFI - used for encapsulating Token Ring packets so they can be carried across Ethernet backbones), and 12 bits of **VLAN ID (VID)**. The 3 bits of user priority are used by 802.1p. The VID is the VLAN identifier and is used by the 802.1Q standard. Because the VID is 12 bits long, 4094 unique VLAN can be identified.

The tag is inserted into the packet header making the entire packet longer by 4 octets. All of the information originally contained in the packet is retained.

**IEEE 802.1Q Tag**

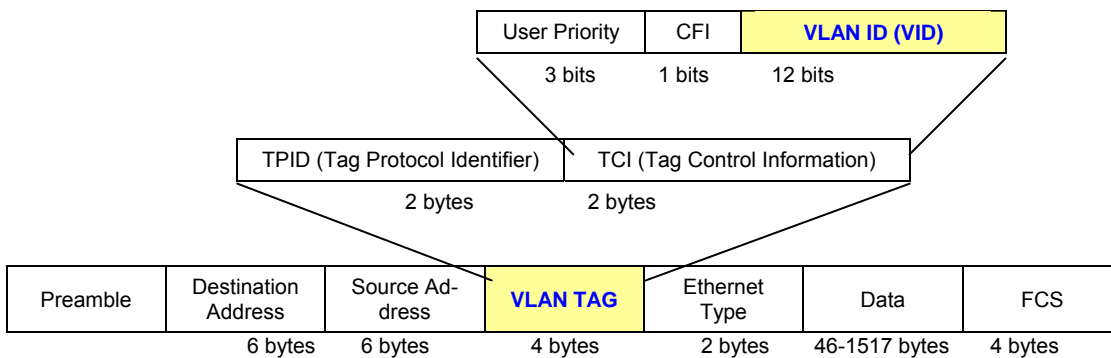

The Ether Type and VLAN ID are inserted after the MAC source address, but before the original Ether Type/Length or Logical Link Control. Because the packet is now a bit longer than it was originally, the Cyclic Redundancy Check (CRC) must be recalculated.

**Adding an IEEE 802.1Q Tag**

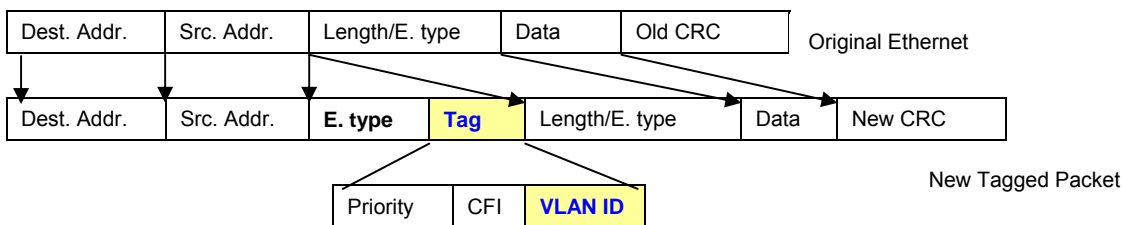

**Port VLAN ID**

Packets that are tagged (are carrying the 802.1Q VID information) can be transmitted from one 802.1Q compliant network device to another with the VLAN information intact. This allows 802.1Q VLAN to span network devices (and indeed, the entire network – if all network devices are 802.1Q compliant).

Every physical port on a switch has a **PVID**. 802.1Q ports are also assigned a PVID, for use within the switch. If no VLAN are defined on the switch, all ports are then assigned to a default VLAN with a PVID equal to 1. Untagged packets are assigned the PVID of the port on which they were received. Forwarding decisions are based upon this PVID, in so far as VLAN are concerned. Tagged packets are forwarded according to the VID contained within the tag. Tagged packets are also assigned a PVID, but the PVID is not used to make packet forwarding decisions, the VID is.

Tag-aware switches must keep a table to relate PVID within the switch to VID on the network. The switch will compare the VID of a packet to be transmitted to the VID of the port that is to transmit the packet. If the two VID are different the switch will drop the packet. Because of the existence of the PVID for untagged packets and the VID for tagged packets, tag-aware and tag-unaware network devices can coexist on the same network.

A switch port can have only one PVID, but can have as many VID as the switch has memory in its VLAN table to store them.

Because some devices on a network may be tag-unaware, a decision must be made at each port on a tag-aware device before packets are transmitted – should the packet to be transmitted have a tag or not? If the transmitting port is connected to a tag-unaware device, the packet should be untagged. If the transmitting port is connected to a tag-aware device, the packet should be tagged.

### Default VLANs

The Switch initially configures one VLAN, VID = 1, called "**default**." The factory default setting assigns all ports on the Switch to the "**default**". As new VLAN are configured in Port-based mode, their respective member ports are removed from the "default."



Note

The Switch supports **SVL(Shared VLAN Learning)** , all VLAN groups share the same Layer 2 learned MAC address table.



Note

- 1 No matter what basis is used to uniquely identify end nodes and assign these nodes VLAN membership, packets cannot cross VLAN without a network device performing a routing function between the VLAN.
- 2 The Switch supports Port-based VLAN and IEEE 802.1Q VLAN. The port untagging function can be used to remove the 802.1 tag from packet headers to maintain compatibility with devices that are tag-unaware.

### 4.5.1 VLAN Group

The VLAN Group page contains fields for managing VLAN mode of the Switch and setting ports that are part of a VLAN. The port default VLAN ID (PVID) is configured on the VLAN Port Configuration page. All untagged packets arriving to the device are tagged by the ports PVID. The screen in [Figure 4-16](#) and [4-17](#) appears.

The VLAN mode had three modes:

- **Disable (No VLAN)**
- **Port-Based VLAN**
- **802.1Q VLAN**

This function group individual ports into a small “**Virtual**” network of their own to be independent of the other ports. The screen in [Figure 3-6](#) appears.

The Switch supports **Port-based** and **802.1Q** (Tagged-based) in Web management page. In the default configuration, VLAN support is “**Disable**”.

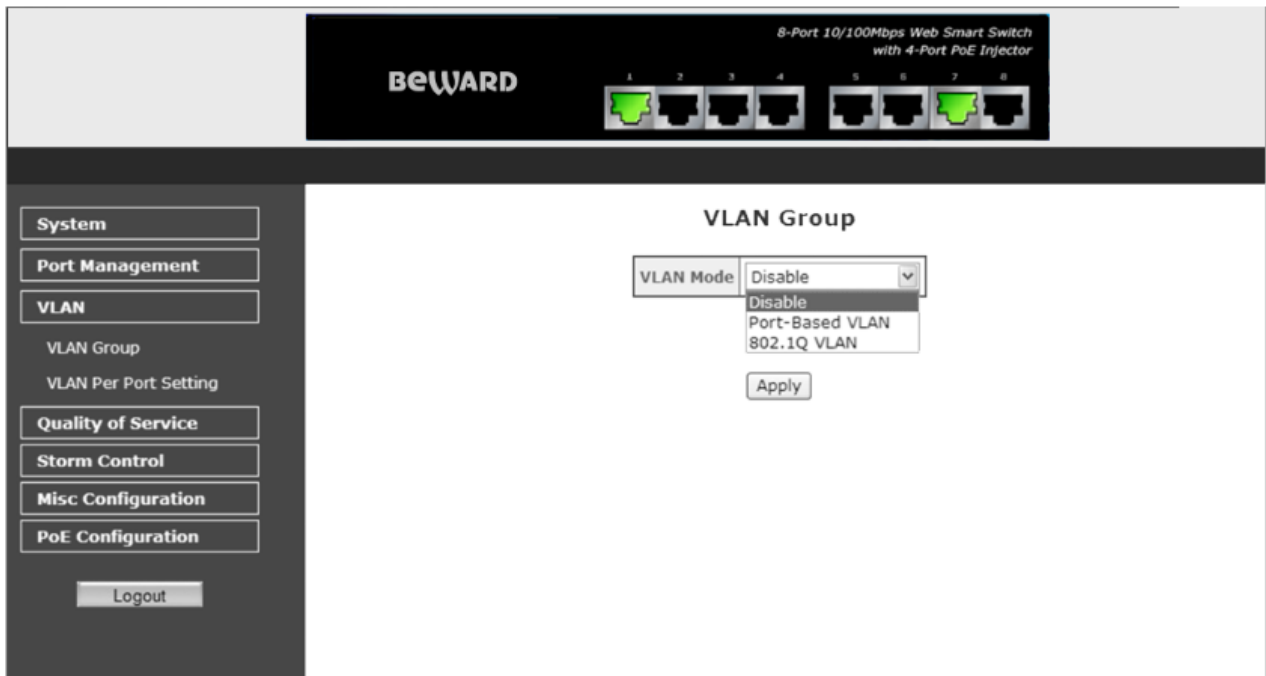

**Figure 4-23** VLAN Group screenshot

Object	Description
<b>VLAN Type</b>	<p>There're three VLAN mode support – 802.1Q VLAN, Port-Bas VLAN and Disable (No VLAN).</p> <ul style="list-style-type: none"> <li>• <b>802.1Q</b> – Packets income will be tagged with VID as the PVID setting. All ports on the switch belong to default VLAN (VID 1).</li> <li>• <b>Port-Base</b> - Packets can only be broadcast among other members of the same VLAN group. Note all unselected ports are treated as belonging to the default system VLAN.</li> <li>• <b>Disable</b> - Forbidden ports are not included in the VLAN</li> </ul> <p>If Port-based VLAN are enabled, then VLAN-tagging feature is ignored.</p>

**4.5.1.1 Port-Based VLAN**

By setting the VLAN Type with **Port-Based**, Port-Based VLAN is enabled and 802.1Q VLAN tagging is ignored. The VLAN group classification of an incoming packet on a Port-Based VLAN is defined by the VLAN group table.

A port is limited to communicate with other ports within the same group when the function is enabled and configured. Frame will be limited in a VLAN group and will not be forwarded out this VLAN group. A port can be assigned to one or more VLAN groups.

### VLAN Group

VLAN Mode Port-Based VLAN

Management VLAN Group 1

VLAN Group	Member Port							
	1	2	3	4	5	6	7	8
VLAN 1	<input checked="" type="checkbox"/>	<input checked="" type="checkbox"/>	<input checked="" type="checkbox"/>	<input checked="" type="checkbox"/>	<input checked="" type="checkbox"/>	<input checked="" type="checkbox"/>	<input checked="" type="checkbox"/>	<input checked="" type="checkbox"/>
VLAN 2	<input type="checkbox"/>	<input type="checkbox"/>	<input type="checkbox"/>	<input type="checkbox"/>	<input type="checkbox"/>	<input type="checkbox"/>	<input type="checkbox"/>	<input type="checkbox"/>
VLAN 3	<input type="checkbox"/>	<input type="checkbox"/>	<input type="checkbox"/>	<input type="checkbox"/>	<input type="checkbox"/>	<input type="checkbox"/>	<input type="checkbox"/>	<input type="checkbox"/>
VLAN 4	<input type="checkbox"/>	<input type="checkbox"/>	<input type="checkbox"/>	<input type="checkbox"/>	<input type="checkbox"/>	<input type="checkbox"/>	<input type="checkbox"/>	<input type="checkbox"/>
VLAN 5	<input type="checkbox"/>	<input type="checkbox"/>	<input type="checkbox"/>	<input type="checkbox"/>	<input type="checkbox"/>	<input type="checkbox"/>	<input type="checkbox"/>	<input type="checkbox"/>
VLAN 6	<input type="checkbox"/>	<input type="checkbox"/>	<input type="checkbox"/>	<input type="checkbox"/>	<input type="checkbox"/>	<input type="checkbox"/>	<input type="checkbox"/>	<input type="checkbox"/>
VLAN 7	<input type="checkbox"/>	<input type="checkbox"/>	<input type="checkbox"/>	<input type="checkbox"/>	<input type="checkbox"/>	<input type="checkbox"/>	<input type="checkbox"/>	<input type="checkbox"/>
VLAN 8	<input type="checkbox"/>	<input type="checkbox"/>	<input type="checkbox"/>	<input type="checkbox"/>	<input type="checkbox"/>	<input type="checkbox"/>	<input type="checkbox"/>	<input type="checkbox"/>

Apply
Clear

**Figure 4-24** VLAN Group – **Port-Based** VLAN screen

While Port-Based VLAN mode is selected, the displayed page includes the following configurable data:

Object	Description
<b>VLAN Type</b>	<p>There're three VLAN mode support – 802.1Q VLAN, Port-Bas VLAN and No VLAN.</p> <ul style="list-style-type: none"> <li>• <b>802.1Q</b> – Packets income will be tagged with VID as the PVID setting. All ports on the switch belong to default VLAN (VID 1).</li> <li>• <b>Port-Base</b> - Packets can only be broadcast among other members of the same VLAN group. Note all unselected ports are treated as belonging to the default system VLAN.</li> <li>• <b>Disable</b> - Forbidden ports are not included in the VLAN</li> </ul> <p>If Port-based VLAN are enabled, then VLAN-tagging feature is ignored.</p>

<b>Management VLAN</b>	Specifies the management VLAN ID of the Switch. It may be configured to any value in the range of <b>1 - 16</b> . The management VLAN is used for management of the Switch.
<b>VLAN Group</b>	At Port-Based VLAN mode, up to 8 VLAN groups can be configured.
<b>Member Port</b>	Select the physical interface for which you want to display or configure data.

**4.5.1.2 IEEE 802.1Q VLAN**

This function group individual ports into a small “**Virtual**” network of their own to be independent of the other ports. The By setting the VLAN Type with **802.1Q**, IEEE 802.1Q tag-based VLAN is enabled. VLAN classification is the first step before VLAN table lookup. The PoE Switch will check the VID value of the received packets and the VLAN table ingress/egress rule, then forwards the packets to valid destination ports.

Select “**802.1Q VLAN**” and press “**Apply**” button, to enable the IEEE 802.1Q VLAN function then continue configure sixteen 802.1Q VLAN groups as your request. After setup completed, please press “**Apply**” to take affect. The IEEE 802.1Q VLAN Group member configuration screen in [Figure 4-25](#) appears.

**VLAN Group**

VLAN Mode 802.1Q VLAN

Management VLAN Group 1

VLAN Group	VID	Member							
		1	2	3	4	5	6	7	8
1	<input type="text" value="1"/>	<input checked="" type="checkbox"/>	<input checked="" type="checkbox"/>	<input checked="" type="checkbox"/>	<input checked="" type="checkbox"/>	<input checked="" type="checkbox"/>	<input checked="" type="checkbox"/>	<input checked="" type="checkbox"/>	<input checked="" type="checkbox"/>
2	<input type="text" value="2"/>	<input type="checkbox"/>	<input type="checkbox"/>	<input type="checkbox"/>	<input type="checkbox"/>	<input type="checkbox"/>	<input type="checkbox"/>	<input type="checkbox"/>	<input type="checkbox"/>
3	<input type="text" value="3"/>	<input type="checkbox"/>	<input type="checkbox"/>	<input type="checkbox"/>	<input type="checkbox"/>	<input type="checkbox"/>	<input type="checkbox"/>	<input type="checkbox"/>	<input type="checkbox"/>
4	<input type="text" value="4"/>	<input type="checkbox"/>	<input type="checkbox"/>	<input type="checkbox"/>	<input type="checkbox"/>	<input type="checkbox"/>	<input type="checkbox"/>	<input type="checkbox"/>	<input type="checkbox"/>
5	<input type="text" value="5"/>	<input type="checkbox"/>	<input type="checkbox"/>	<input type="checkbox"/>	<input type="checkbox"/>	<input type="checkbox"/>	<input type="checkbox"/>	<input type="checkbox"/>	<input type="checkbox"/>
6	<input type="text" value="6"/>	<input type="checkbox"/>	<input type="checkbox"/>	<input type="checkbox"/>	<input type="checkbox"/>	<input type="checkbox"/>	<input type="checkbox"/>	<input type="checkbox"/>	<input type="checkbox"/>
7	<input type="text" value="7"/>	<input type="checkbox"/>	<input type="checkbox"/>	<input type="checkbox"/>	<input type="checkbox"/>	<input type="checkbox"/>	<input type="checkbox"/>	<input type="checkbox"/>	<input type="checkbox"/>
8	<input type="text" value="8"/>	<input type="checkbox"/>	<input type="checkbox"/>	<input type="checkbox"/>	<input type="checkbox"/>	<input type="checkbox"/>	<input type="checkbox"/>	<input type="checkbox"/>	<input type="checkbox"/>

**Figure 4-25** VLAN Group – 802.1Q VLAN screen

The page includes the following fields:

Object	Description
<b>VLAN Type</b>	<p>There're two VLAN mode support – 802.1Q VLAN and Port-Bas VLAN</p> <ul style="list-style-type: none"> <li>• <b>802.1Q</b> – Packets income will be tagged with VID as the PVID setting. All ports on the switch belong to default VLAN (VID 1).</li> <li>• <b>Port-Base</b> - Packets can only be broadcast among other members of the same VLAN group. Note all unselected ports are treated as belonging to the default system VLAN.</li> <li>• <b>Disable</b> - Forbidden ports are not included in the VLAN</li> </ul>
<b>Management VLAN</b>	<p>Specifies the management VLAN ID of the Switch. It may be configured to any value in the range of <b>1 - 16</b>. The management VLAN is used for management of the Switch.</p>
• <b>VLAN Group</b>	<p>The VLAN entry index. Select the column to specify the VLAN group for VLAN member ports configure.</p> <p>The Switch supports up to <b>16</b> active VLAN groups.</p>
• <b>VID</b>	<p>Specify the VLAN Identifier for the 802.1Q VLAN.</p> <p>The available range of the VID is (<b>1 to 4094</b>).</p> <p>( <b>802.1Q mode only</b>)</p>
• <b>Member Port</b>	<p>Select the physical interface for which you want to add or remove from the specify VLAN group. Checked the Member box to select the members for the VLAN group. Number 1-8 is the Physical interface ID of the PoE Switch.</p> <p><input checked="" type="checkbox"/> <b>ADD</b>: To add selected ports to the specify VLAN group.</p> <p><input type="checkbox"/> <b>Remove</b>: Remove the selected ports from the specify VLAN Group.</p> <p>After setup completed, please press “<b>Apply</b>” to take affect.</p>



Note

1. The VID value of each VLAN group must follow the rule -> there is an interval value 16 of available VID value. For example, VLAN 2 VID must be 2, 18, 34, ....; VLAN 3 VID must be 3, 19, 35...
2. There is no way to delete a VLAN group on the PoE Switch. Just cancel all the check box from Port-1 to Port-8 to make the VLAN group be not active.
3. Once the member port be removed from VLAN Group, the Ports with the PVID set to this VLAN Group have to re-configure the PVID.



### 4.5.2 VLAN Per Port Setting

The PoE Switch inserts or removes a tag of frame if Tag / UnTag function is enabled. The operation is illustrated as follows.

#### Understand nomenclature of the 802.1Q VLAN aware Switch

##### Tagging and Untagging

Every port on an 802.1Q compliant switch can be configured as tagging or untagging.

- **Tagging:** Ports with tagging enabled will put the VID number, priority and other VLAN information into the header of all packets that flow into those ports. If a packet has previously been tagged, the port will not alter the packet, thus keeping the VLAN information intact. The VLAN information in the tag can then be used by other 802.1Q compliant devices on the network to make packet-forwarding decisions.
- **Untagging:** Ports with untagging enabled will strip the 802.1Q tag from all packets that flow into those ports. If the packet doesn't have an 802.1Q VLAN tag, the port will not alter the packet. Thus, all packets received by and forwarded by an untagging port will have no 802.1Q VLAN information. (Remember that the PVID is only used internally within the Switch). Untagging is used to send packets from an 802.1Q-compliant network device to a non-compliant network device.

Frame Income / Frame Leave	Income Frame is <b>tagged</b>	Income Frame is <b>untagged</b>
Leave port is tagged	Frame remains tagged	Tag is inserted (Tag=PVID or Original VID be remained)
Leave port is untagged	Tag is removed	Frame remain untagged (Tag=PVID be removed)

### 802.1Q VLAN Per Port Setting

Port	Link Type	PVID
1	UnTag ▾	1 ▾
2	UnTag ▾	1 ▾
3	UnTag ▾	1 ▾
4	UnTag ▾	1 ▾
5	UnTag ▾	1 ▾
6	UnTag ▾	1 ▾
7	UnTag ▾	1 ▾
8	UnTag ▾	1 ▾

Apply

**Figure 4-26** VLAN Per port setting screen

The page includes the following fields:

Object	Description
<b>Port</b>	Indicate the physical interface for which you want to display or configure data.
<b>Link Type</b>	<p>Allow 802.1Q Untagged or Tagged VLAN for selected port.</p> <p>When adding a VLAN to selected port, it tells the switch whether to keep or remove the tag from a frame on <b>egress</b>.</p> <ul style="list-style-type: none"><li>• <b>Untag:</b> outgoing frames without VLAN-Tagged.</li><li>• <b>Tagged:</b> outgoing frames with VLAN-Tagged.</li></ul> <p><b>( 802.1Q mod only)</b></p>
<b>PVID</b>	<p>Allow assign PVID for selected port. The range for the PVID is <b>1-4094</b></p> <p>The PVID will be inserted into all <b>untagged</b> frames entering the <b>ingress</b> port. The PVID must as same as the VLAN ID that the port belong to VLAN group, or the untagged traffic will be dropped.</p>

### 4.5.3 VLAN setting example:

#### 4.5.3.1 Two separate 802.1Q VLAN

The diagram shows how the switch handle Tagged and Untagged traffic flow for two VLANs. **VLAN Group 2** and **VLAN Group 3** are separated VLAN. Each VLAN isolate network traffic so only members of the VLAN receive traffic from the same VLAN members. The screen in [Figure 4-20](#) appears and [Table 4-4](#) describes the port configuration of switch.

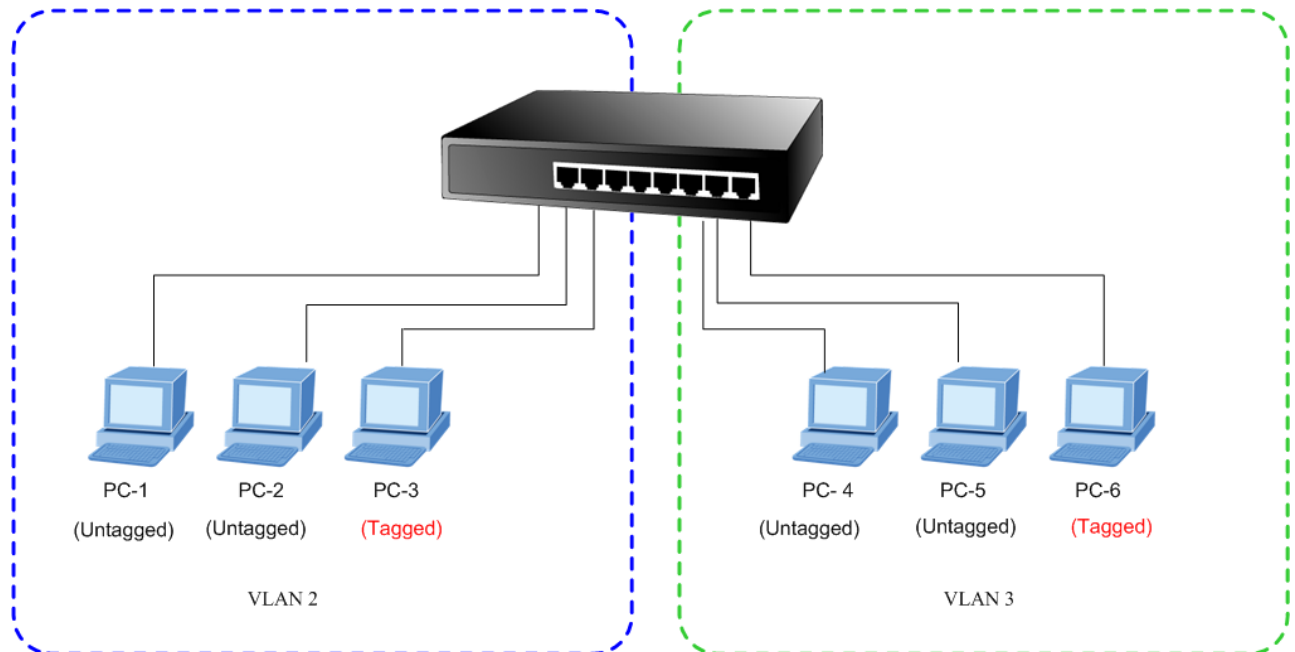

Figure 4-27 two separate VLAN diagram

VLAN Group	VID	Untagged Members	Tagged Members
VLAN Group 1	1	Port-7~Port-8	N/A
VLAN Group 2	2	Port-1,Port-2	Port-3
VLAN Group 3	3	Port-4,Port-5	Port-6

Table 4-4 VLAN and Port Configuration

The scenario described as follow:

- **Untagged packet entering VLAN 2**
  1. While [PC-1] transmit an **untagged** packet enters **Port-1**, the switch will tag it with a **VLAN Tag=2**. [PC-2] and [PC-3] will received the packet through **Port-2** and **Port-3**.
  2. [PC-4],[PC-5] and [PC-6] received no packet.
  3. While the packet leaves **Port-2**, it will be stripped away it tag becoming an **untagged** packet.
  4. While the packet leaves **Port-3**, it will keep as a **tagged** packet with **VLAN Tag=2**.
- **Tagged packet entering VLAN 2**
  5. While [PC-3] transmit a **tagged** packet with **VLAN Tag=2** enters **Port-3**, [PC-1] and [PC-2] will received the packet through **Port-1** and **Port-2**.
  6. While the packet leaves **Port-1** and **Port-2**, it will be stripped away it tag becoming an **untagged** packet.

■ **Untagged packet entering VLAN 3**

1. While [PC-4] transmit an **untagged** packet enters **Port-4**, the switch will tag it with a **VLAN Tag=3**. [PC-5] and [PC-6] will received the packet through **Port-5** and **Port-6**.
2. While the packet leaves **Port-5**, it will be stripped away it tag becoming an **untagged** packet.
3. While the packet leaves **Port-6**, it will keep as a **tagged** packet with **VLAN Tag=3**.



At this example, VLAN Group 1 just set as default VLAN, but only focus on VLAN 2 and VLAN 3 traffic flow

**Setup steps**

**1. Create VLAN Group**

Set **VALN Group 1** = default-VLAN with VID (VLAN ID)=1

Add two VLANs – VLAN 2 and VLAN 3

**VLAN Group 2** with VID=2

**VLAN Group 3** with VID=3

**2. Assign VLAN Member :**

VLAN 2 : *Port-1,Port-2 and Port-3*

VLAN 3 : *Port-4, Port-5 and Port-6*

VLAN 1 : All other ports – *Port-7~Port-8*

**VLAN Group**

VLAN Mode 802.1Q VLAN

Management VLAN Group 1

VLAN Group	VID	Member							
		1	2	3	4	5	6	7	8
1	1	<input type="checkbox"/>	<input type="checkbox"/>	<input type="checkbox"/>	<input type="checkbox"/>	<input type="checkbox"/>	<input type="checkbox"/>	<input checked="" type="checkbox"/>	<input checked="" type="checkbox"/>
2	2	<input checked="" type="checkbox"/>	<input checked="" type="checkbox"/>	<input checked="" type="checkbox"/>	<input type="checkbox"/>	<input type="checkbox"/>	<input type="checkbox"/>	<input type="checkbox"/>	<input type="checkbox"/>
3	3	<input type="checkbox"/>	<input type="checkbox"/>	<input type="checkbox"/>	<input checked="" type="checkbox"/>	<input checked="" type="checkbox"/>	<input checked="" type="checkbox"/>	<input type="checkbox"/>	<input type="checkbox"/>
4	4	<input type="checkbox"/>	<input type="checkbox"/>	<input type="checkbox"/>	<input type="checkbox"/>	<input type="checkbox"/>	<input type="checkbox"/>	<input type="checkbox"/>	<input type="checkbox"/>
5	5	<input type="checkbox"/>	<input type="checkbox"/>	<input type="checkbox"/>	<input type="checkbox"/>	<input type="checkbox"/>	<input type="checkbox"/>	<input type="checkbox"/>	<input type="checkbox"/>
6	6	<input type="checkbox"/>	<input type="checkbox"/>	<input type="checkbox"/>	<input type="checkbox"/>	<input type="checkbox"/>	<input type="checkbox"/>	<input type="checkbox"/>	<input type="checkbox"/>
7	7	<input type="checkbox"/>	<input type="checkbox"/>	<input type="checkbox"/>	<input type="checkbox"/>	<input type="checkbox"/>	<input type="checkbox"/>	<input type="checkbox"/>	<input type="checkbox"/>

Figure 4-28 Assign VLAN 2 Group members screen

Remember to remove the Port 1 – Port 6 from VLAN 1 membership, since the Port 1 – Port 6 had been assigned to VLAN 2 and VLAN 3.



Note

It's import to remove the VLAN members from VLAN 1 configuration. Or the ports would become overlap setting. ( About the overlapped VLAN configuration, see next VLAN configure sample)

### 3. Assign PVID for each port:

Port-1,Port-2 and Port-3 : PVID=2

Port-4,Port-5 and Port-6 : PVID=3

Port-7~Port-8: PVID=1

### 4. Enable VLAN Tag for specific ports

Link Type: *Port-3* (VLAN-2) and *Port-6* (VLAN-3) be set to "Tagged".

The Per Port VLAN configuration in [Figure 4-24](#) appears.

## 802.1Q VLAN Per Port Setting

Port	Link Type	PVID
1	UnTag	2
2	UnTag	2
3	Tag	2
4	UnTag	3
5	UnTag	3
6	Tag	3
7	UnTag	1
8	UnTag	1

Apply

Figure 4-29 Port 1-Port 8 VLAN Configuration

4.5.3.2 Two VLANs with overlap area

Follow the example of 4.5.3.1. There're two exist separate VLANs – VLAN 2 and VLAN 3, and the PCs of each VLANs are not able to access each other of different VLANs. But they all need to access with the same server. The screen in [Figure 4-25](#) appear. This section will show you how to configure the port for the server – that could be accessed by both VLAN 2 and VLAN 3.

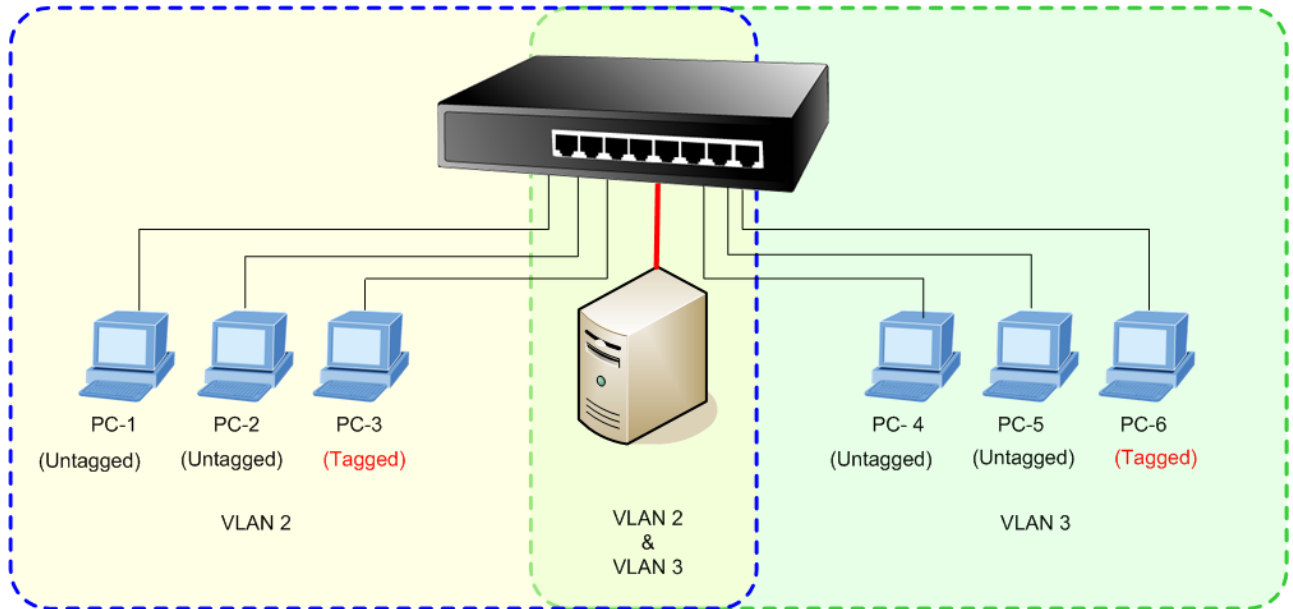

Figure 4-30 A Server connect to the VLAN overlap area

1. Specify **Port-8** on the device to connect to the server.
2. Assign **Port-8** to both **VLAN 2** and **VLAN 3** at the VLAN Member configuration page. The screen in [Figure 4-26](#) appears.

VLAN Group

VLAN Mode: 802.1Q VLAN

Management VLAN Group: 1

VLAN Group	VID	Member							
		1	2	3	4	5	6	7	8
1	1	<input type="checkbox"/>	<input type="checkbox"/>	<input type="checkbox"/>	<input type="checkbox"/>	<input type="checkbox"/>	<input type="checkbox"/>	<input checked="" type="checkbox"/>	<input checked="" type="checkbox"/>
2	2	<input checked="" type="checkbox"/>	<input checked="" type="checkbox"/>	<input checked="" type="checkbox"/>	<input type="checkbox"/>	<input type="checkbox"/>	<input type="checkbox"/>	<input type="checkbox"/>	<input checked="" type="checkbox"/>
3	3	<input type="checkbox"/>	<input type="checkbox"/>	<input type="checkbox"/>	<input checked="" type="checkbox"/>	<input checked="" type="checkbox"/>	<input checked="" type="checkbox"/>	<input type="checkbox"/>	<input checked="" type="checkbox"/>
4	4	<input type="checkbox"/>	<input type="checkbox"/>	<input type="checkbox"/>	<input type="checkbox"/>	<input type="checkbox"/>	<input type="checkbox"/>	<input type="checkbox"/>	<input type="checkbox"/>
5	5	<input type="checkbox"/>	<input type="checkbox"/>	<input type="checkbox"/>	<input type="checkbox"/>	<input type="checkbox"/>	<input type="checkbox"/>	<input type="checkbox"/>	<input type="checkbox"/>
6	6	<input type="checkbox"/>	<input type="checkbox"/>	<input type="checkbox"/>	<input type="checkbox"/>	<input type="checkbox"/>	<input type="checkbox"/>	<input type="checkbox"/>	<input type="checkbox"/>
7	7	<input type="checkbox"/>	<input type="checkbox"/>	<input type="checkbox"/>	<input type="checkbox"/>	<input type="checkbox"/>	<input type="checkbox"/>	<input type="checkbox"/>	<input type="checkbox"/>

Figure 4-31 VLAN overlap port setting

- Define a **VLAN 1** as a "Public Area" that overlapping with both **VLAN 2 members** and **VLAN 3 members**.

### VLAN Group

VLAN Mode: 802.1Q VLAN

Management VLAN Group: 1

VLAN Group	VID	Member							
		1	2	3	4	5	6	7	8
1	1	<input checked="" type="checkbox"/>	<input checked="" type="checkbox"/>	<input checked="" type="checkbox"/>	<input checked="" type="checkbox"/>	<input checked="" type="checkbox"/>	<input checked="" type="checkbox"/>	<input checked="" type="checkbox"/>	<input checked="" type="checkbox"/>
2	2	<input checked="" type="checkbox"/>	<input checked="" type="checkbox"/>	<input checked="" type="checkbox"/>	<input type="checkbox"/>	<input type="checkbox"/>	<input type="checkbox"/>	<input type="checkbox"/>	<input checked="" type="checkbox"/>
3	3	<input type="checkbox"/>	<input type="checkbox"/>	<input type="checkbox"/>	<input checked="" type="checkbox"/>	<input checked="" type="checkbox"/>	<input checked="" type="checkbox"/>	<input type="checkbox"/>	<input checked="" type="checkbox"/>

Figure 4-32 VLAN 1 – The public area member assigning

- Setup **Port-8** with "PVID=1" at VLAN per Port Configuration page. The screen in [Figure 4-28](#) appears.

### 802.1Q VLAN Per Port Setting

Port	Link Type	PVID
1	UnTag	2
2	UnTag	2
3	Tag	2
4	UnTag	3
5	UnTag	3
6	Tag	3
7	UnTag	1
8	UnTag	1

Apply

Figure 4-33 Setup Port-8 with PVID-1

That is, although the **VLAN 2 members: Port-1 to Port-3** and **VLAN 3 members: Port-4 to Port-6**, are also belonging to **VLAN 1**. But with different PVID settings, packets from VLAN 2 or VLAN 3 is not able to access to the other VLAN.

#### 4.5.3.3 Port-based VLAN setting example:

##### VLAN scenario

1. **Port-8** is the file server port for all the workstations
2. **Port-1** to **Port-7** is different devices that do not need to see each other

##### Setup steps

1. Port Setting
  - 1.1 Assign **VLAN 2** for the second VLAN group with **Port-1** and **Port-8**
  - 1.2 Repeat the same steps for Port-2 to Port-7. i.e. 2 & 8, 3 & 8, ....., 7 & 8

After the above steps Port-1 to Port-7 is being separated physically due to it belongs to different VLAN groups (different VLAN). However, they all can access Port-8 due to Port-8 is using PVID 1 to communicate with Port-1 to Port-7.

### VLAN Group

VLAN Mode Port-Based VLAN ▼

Management VLAN Group 1 ▼

VLAN Group	Member Port							
	1	2	3	4	5	6	7	8
VLAN 1	<input checked="" type="checkbox"/>	<input type="checkbox"/>	<input type="checkbox"/>	<input type="checkbox"/>	<input type="checkbox"/>	<input type="checkbox"/>	<input type="checkbox"/>	<input checked="" type="checkbox"/>
VLAN 2	<input type="checkbox"/>	<input checked="" type="checkbox"/>	<input type="checkbox"/>	<input type="checkbox"/>	<input type="checkbox"/>	<input type="checkbox"/>	<input type="checkbox"/>	<input checked="" type="checkbox"/>
VLAN 3	<input type="checkbox"/>	<input type="checkbox"/>	<input checked="" type="checkbox"/>	<input type="checkbox"/>	<input type="checkbox"/>	<input type="checkbox"/>	<input type="checkbox"/>	<input checked="" type="checkbox"/>
VLAN 4	<input type="checkbox"/>	<input type="checkbox"/>	<input type="checkbox"/>	<input checked="" type="checkbox"/>	<input type="checkbox"/>	<input type="checkbox"/>	<input type="checkbox"/>	<input checked="" type="checkbox"/>
VLAN 5	<input type="checkbox"/>	<input type="checkbox"/>	<input type="checkbox"/>	<input type="checkbox"/>	<input checked="" type="checkbox"/>	<input type="checkbox"/>	<input type="checkbox"/>	<input checked="" type="checkbox"/>
VLAN 6	<input type="checkbox"/>	<input type="checkbox"/>	<input type="checkbox"/>	<input type="checkbox"/>	<input type="checkbox"/>	<input checked="" type="checkbox"/>	<input type="checkbox"/>	<input checked="" type="checkbox"/>
VLAN 7	<input type="checkbox"/>	<input type="checkbox"/>	<input type="checkbox"/>	<input type="checkbox"/>	<input type="checkbox"/>	<input type="checkbox"/>	<input checked="" type="checkbox"/>	<input checked="" type="checkbox"/>
VLAN 8	<input type="checkbox"/>	<input type="checkbox"/>	<input type="checkbox"/>	<input type="checkbox"/>	<input type="checkbox"/>	<input type="checkbox"/>	<input type="checkbox"/>	<input type="checkbox"/>

Figure 4-34 Port-Based VLAN setting example



## 4.6 Quality of Service

**Quality of Service (QoS)** is an advanced traffic prioritization feature that allows you to establish control over network traffic. QoS enables you to assign various grades of network service to different types of traffic, such as multi-media, video, protocol-specific, time critical, and file-backup traffic.

QoS reduces bandwidth limitations, delay, loss, and jitter. It also provides increased reliability for delivery of your data and allows you to prioritize certain applications across your network. You can define exactly how you want the switch to treat selected applications and types of traffic.

You can use QoS on your system to:

- Classifying traffic based on packet attributes.
- Assigning priorities to traffic (for example, to set higher priorities to time-critical or business-critical applications).
- Applying security policy through traffic filtering.
- Provide predictable throughput for multimedia applications such as video conferencing or voice over IP by minimizing delay and jitter.
- Improve performance for specific types of traffic and preserve performance as the amount of traffic grows.
- Reduce the need to constantly add bandwidth to the network.
- Manage network congestion.

The **QoS** page of the PoE Switch contains three types of QoS mode - the **802.1p** mode, **DSCP** mode or **Port-base** mode can be selected. Both the three mode rely on predefined fields within the packet to determine the output queue.

- **802.1p Tag Priority Mode** –The output queue assignment is determined by the IEEE 802.1p VLAN priority tag.
- **IP DSCP Mode** - The output queue assignment is determined by the TOS or DSCP field in the IP packets.
- **Port-Base Priority Mode** – Any packet received from the specify high priority port will treated as a high priority packet.

The PoE Switch supports **two priority level** queue, the queue service rate is based on the **WRR(Weight Round Robin)** alorithm. The WRR ratio of high-priority and low-priority can be set to **“4:1 and 8:1**.

The screen in [Figure 4-35](#) shows the Quality of Service configuration page.

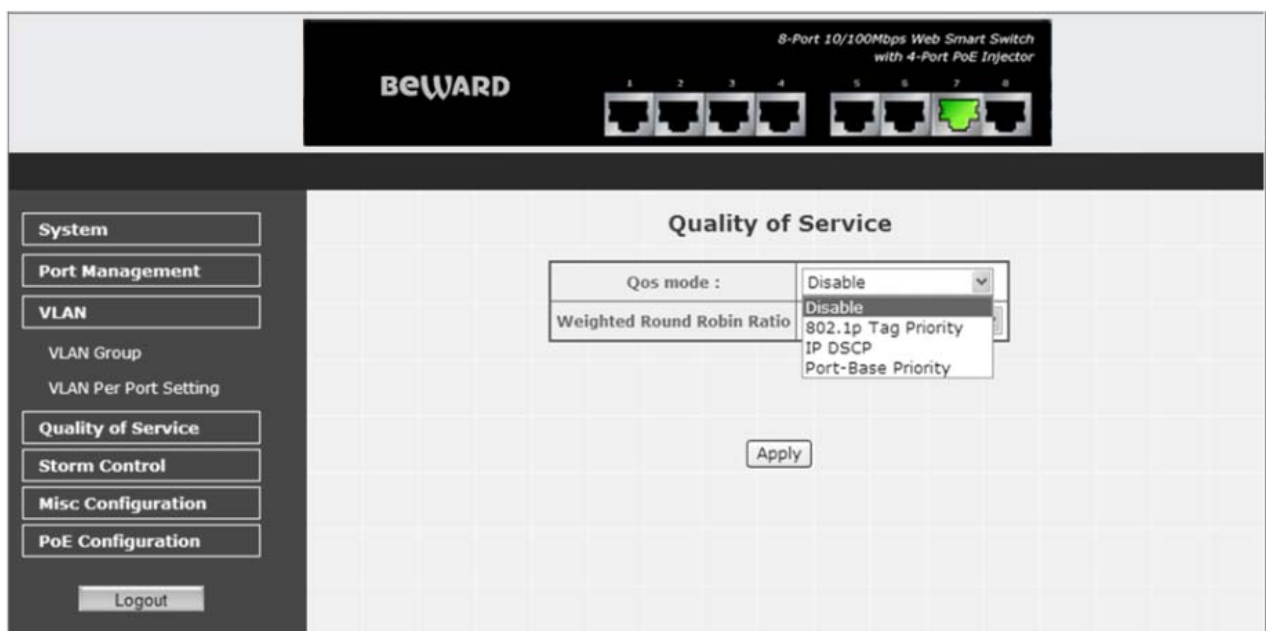
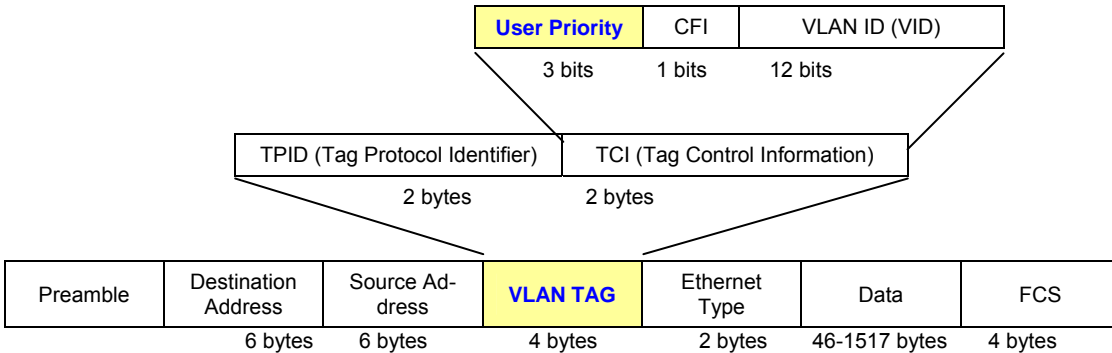

**Figure 4-35** Quality of Service screen

### 4.6.1 802.1p Tag Priority Mode

QoS settings allow customization of packet priority in order to facilitate delivery of data traffic that might be affected by latency problems. When 802.1p Tag Priority is applied, the PoE Switch recognizes 802.1Q VLAN tag packets and extracts the VLAN tagged packets with User Priority value.

#### 802.1Q Tag and 802.1p priority



**Figure 4-36** 802.1p Tag Priority

The IEEE 802.1p Tag Priority specification uses 2 priority levels to classify data packets. The screen in [Figure 4-37](#) appears.

### Quality of Service

Qos mode :	802.1p Tag Priority ▼
Weighted Round Robin Ratio	Highest:Lowest=4:1 ▼

	IEEE 802.1p priority value from VLAN tag
High Priority	User priority values = 4~7
Low Priority	User priority values = 0~3

**Figure 4-37** QoS - 802.1p Tag Priority screen

The page includes the following fields:

• Object	• Description
• <b>QoS Mode</b>	The draw menu allows customization of QoS mode for Traffic classifiers. <ul style="list-style-type: none"> <li>• <b>802.1p Tag Priority</b></li> <li>• IP DSCP</li> <li>• Port-Base Priority</li> </ul>

<b>Weighted Round Robin Ratio</b>	<p>Weighted Round Robin ratio setting of priority queue.</p> <p>The frame service rate of High-Priority queue to Low-Priority queue options are shown as below:</p> <ul style="list-style-type: none"><li>• <b>Highest:Lowest=4:1</b></li><li>• <b>Highest:Lowest=8:1</b></li></ul>
-----------------------------------	---

The PoE Switch had define the VLAN tagged packets with User Priority value 4~7 are treated as high priority packets, and the other User Priority values (0~3) as low priority packets. The User Priority follows the IEEE 802.1p standard).

	IEEE 802.1p priority value from VLAN tag
<b>High Priority</b>	User priority values= 4~7
<b>Low Priority</b>	User priority values= 0~3

### 4.6.2 DSCP QoS Mode

**DiffServ Code Point (DSCP)** – is the traffic prioritization bits within an IP header that are encoded by certain applications and/or devices to indicate the level of service required by the packet across a network.

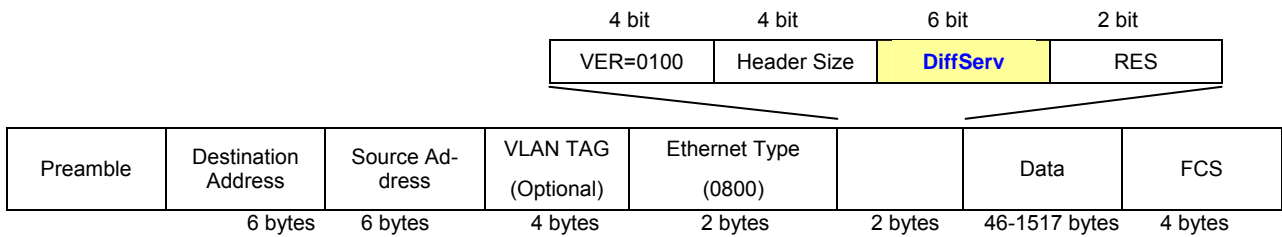

**Figure 4-38** IPv4 frame format

The **Quality of Service** page provides fields for defining output queue to specific DSCP fields. When TCP/IP's TOS/DSCP mode is applied, the PoE Switch recognizes TCP/IP Differentiated Service Codepoint (DSCP) priority information from the DS-field defined in RFC2474. Select the QoS mode to IP DSCP, the DSCP to priority mapping page appears, as the [Figure 4-39](#) shows.

### Quality of Service

Qos mode :	IP DSCP
Weighted Round Robin Ratio	Highest:Lowest=4:1

DSCP Configuration	
Priority	DSCP Value (0~63)
High	18
	26
	34
	46
	48
	56
	0
Low	Other

Suggest TOS/DSCP Value							
High Priority	DSCP 46	DSCP 10	DSCP 18	DSCP 26	DSCP 34	DSCP 48	DSCP 56
Low Priority	Other DSCP values						

Apply

**Figure 4-39** DSCP QoS Configuration screen

The page includes the following fields:

• Object	• Description
• <b>QoS Mode</b>	The draw menu allows customization of QoS mode for Traffic classifiers. <ul style="list-style-type: none"> <li>• 802.1p Tag Priority</li> <li>• <b>IP DSCP</b></li> <li>• Port-Base Priority</li> </ul>
<b>Weighted Round Robin Ratio</b>	Weighted Round Robin ratio setting of priority queue. The frame service rate of High-Priority queue to Low-Priority queue options are shown as below: <ul style="list-style-type: none"> <li>• <b>Highest:Lowest=4:1</b></li> <li>• <b>Highest:Lowest=8:1</b></li> </ul>

DSCP are defined in RFC2597 for classifying traffic into different service classes. The PoE Switch extracts the code point value of the DS field from IPv4 packets and identifies the priority of the incoming IP packets following the definitions listed below:

	Suggest High Priority IP DSCP Value				
<b>High Priority</b>	EF <b>DSCP 46</b> (101110)	AF11 <b>DSCP 10</b> (001010)	AF21 <b>DSCP 18</b> (010010)	AF31 <b>DSCP 26</b> (011010)	AF41 <b>DSCP 34</b> (100010)
<b>Low Priority</b>	Other DSCP values				

**DSCP:** Differentiated Services Code Point

**EF:** Expected Forwarding

**AF:** Assured Forwarding

### 4.6.3 Port-Based Priority Mode

When Port-Based priority is applied, any packets received from a high priority port will be treated as a high priority packet. Select the QoS mode to Port-Based Priority, the Port ID to queue mapping configuration page appears, as the [Figure 4-40](#) shows.

**Quality of Service**

Qos mode :	Port-Base Priority ▼
Weighted Round Robin Ratio	Highest:Lowest=4:1 ▼

Port	Priority
1	High ▼
2	Low ▼
3	Low ▼
4	Low ▼
5	Low ▼
6	Low ▼
7	Low ▼
8	Low ▼

Apply

**Figure 4-40** QoS – Port-Based Priority Configuration screen

The page includes the following fields:

• Object	• Description
• <b>QoS Mode</b>	The draw menu allows customization of QoS mode for Traffic classifiers. <ul style="list-style-type: none"> <li>• 802.1p Tag Priority</li> <li>• IP DSCP</li> <li>• <b>Port-Base Priority</b></li> </ul>
<b>Weighted Round Robin Ratio</b>	Weighted Round Robin ratio setting of priority queue. The frame service rate of High-Priority queue to Low-Priority queue options are shown as below: <ul style="list-style-type: none"> <li>• <b>Highest:Lowest=4:1</b></li> <li>• <b>Highest:Lowest=8:1</b></li> </ul>

## 4.7 Storm Control

The Storm Control function enables each port to drop broadcast packets (Destination MAC Address is "FF-FF-FF-FF-FF-FF") after a continuous received broadcast packets counter count of the defined value of rate threshold..

This function is to control the **Broadcast** Storm and **Multicast** storm packet on each port. The screen [Figure 4-41](#) appears.

**Storm Control**

Storm Control	Enable ▾
Mode	Broadcast Only ▾
Rate Threshold	1/8 ▾

**Figure 4-41-** Storm Control screen

Object	Description
<ul style="list-style-type: none"> <li><b>Storm Control</b></li> </ul>	<p>Enable or disable this broadcast storm protection function by selecting the corresponding line on the pull-down entry field.</p> <ul style="list-style-type: none"> <li><b>Enable</b> – Enable broadcast storm protection function and drops the incoming broadcast or multicast packets.</li> <li><b>Disable</b> – Disable broadcast storm protection function and forwards the incoming broadcast or multicast packets to all ports.</li> </ul> <p>The factory default is <b>Disable</b>.</p>
<ul style="list-style-type: none"> <li><b>Mode</b></li> </ul>	<p>The PoE switch can handle multicast frame as a broadcast frame in broadcast storm protection function by setting this mode:</p> <ul style="list-style-type: none"> <li><b>Broadcast Only</b> - Packets with DA equal to <b>FFFFFFFF</b> are handled as broadcast frame in broadcast protection function.</li> <li><b>Broadcast and Multicast</b> - Packets with DA equal to <b>FFFFFFFF</b> or Multicast frame (<b>01005EXXXXXX</b>) are handled as broadcast frame in broadcast protection function.</li> </ul>
<ul style="list-style-type: none"> <li><b>Rate Threshold</b></li> </ul>	<p>A port of the PoE Switch begins to drop broadcast packets if the received broadcast packets are more than the threshold defined in the Rate Threshold value:</p> <ul style="list-style-type: none"> <li><b>12.5%</b></li> <li><b>25%</b></li> <li><b>50%</b></li> <li><b>62.5%</b></li> </ul> <p>(Unit: packet / 10ms)</p>

## 4.8 Misc Configuration

This section provides Misc Configuration of STW-8P4, it allows configuring Flow Control, MAC Address Aging time and etc for the PoE Switch.

In a dynamic network topology, address aging allows the contents of the address table to always be the most recent and correct. A learned source address entry will be cleared (age out) if it is not updated by the address learning process within a set aging time period. Use this page to set the Address Ageing Timeout for the MAC Address database. The screen in [Figure 4-42](#) appears.

### Misc Configuration

IEEE 802.3x flow control	<input type="radio"/> Disable <input checked="" type="radio"/> Enable
Backpressure	<input type="radio"/> Disable <input checked="" type="radio"/> Enable
Link down power saving	<input checked="" type="radio"/> Disable <input type="radio"/> Enable
Aging time	<input type="radio"/> Disable <input type="radio"/> 30 Sec <input checked="" type="radio"/> 300 Sec
Congested Port Drop	<input type="radio"/> Disable <input checked="" type="radio"/> Enable

**Figure 4-42** Misc Configuration Web Page screen

The Address Learning Table includes the following fields:

Object	Description
<ul style="list-style-type: none"> <li>• <b>IEEE 802.3x flow control</b></li> </ul>	Allow <b>Enable</b> or <b>Disable</b> flow control for selected port. <ul style="list-style-type: none"> <li>• <b>Enable</b> – 802.3x flow control is enabled on <b>Full-Duplex</b> mode.</li> <li>• <b>Disable</b> – No flow control function on Full-Duplex mode.</li> </ul>
<ul style="list-style-type: none"> <li>• <b>Backpressure</b></li> </ul>	Allow <b>Enable</b> or <b>Disable</b> backpressure function for selected port. <ul style="list-style-type: none"> <li>• <b>Enable</b> – Backpressure is enabled on <b>Half-Duplex</b> mode.</li> <li>• <b>Disable</b> – No backpressure function on Half-Duplex mode.</li> </ul>
<ul style="list-style-type: none"> <li>• <b>Link Down power saving</b></li> </ul>	<ul style="list-style-type: none"> <li>• <b>Enable</b> – Enable link down power saving mode</li> <li>• <b>Disable</b> – Disable link down power saving mode.</li> </ul> When the Link down power saving mode is enabled, the system power consumption of this PoE Switch will can be down from 5.6Watts to 4.3watts.
<ul style="list-style-type: none"> <li>• <b>Aging time</b></li> </ul>	Global Enable or Disable MAC table aging time function. An address tag in hashing table will be removed if this function is turned on and its aging timer expires.



	<ul style="list-style-type: none"> <li>• <b>300 sec</b> -</li> </ul>	<p>Enable MAC table aging function. A learned source address entry will be cleared with a period of time if it is not updated by the address learning process. IEEE 802.1D recommends a default of <b>300 seconds</b>, which is the factory default.</p>
	<ul style="list-style-type: none"> <li>• <b>30 sec</b> -</li> </ul>	<p>Enable Fast aging time, a learned source address entry will be cleared within <b>30 seconds</b> if it is not updated by the address learning process.</p>
		<p>• <b>Disable</b> – Disable MAC table aging function.</p>
	<p>Default value: <b>300 sec</b></p>	
<ul style="list-style-type: none"> <li>• <b>Congested Port Drop</b></li> </ul>	<ul style="list-style-type: none"> <li>• <b>Enable</b> -</li> </ul>	<p>Drop an incoming broadcast packet is any port is congested</p>
	<ul style="list-style-type: none"> <li>• <b>Disable</b> -</li> </ul>	<p>Forward an incoming broadcast packet to un-congested ports instead of congested ports</p>

## 4.9 PoE Configuration

### ■ Power Management:

In a power over Ethernet system, operating power is applied from a power source (PSU-power supply unit) over the LAN infrastructure to **powered devices (PDs)**, which are connected to ports. Under some conditions, the total output power required by PDs can exceed the maximum available power provided by the PSU. The system may a prior be planed with a PSU capable of supplying less power than the total potential power consumption of all the PoE ports in the system. In order to maintain the majority of ports active, power management is implemented.

The PSU input power consumption is monitored by measuring voltage and current .The input power consumption is equal to the system's aggregated power consumption .The power management concept allows all ports to be active and activates additional ports, as long as the aggregated power of the system is lower than the power level at which additional PDs cannot be connected .When this value is exceeded, ports will be deactivated, according to user-defined priorities. The power budget is managed according to the following user-definable parameters: maximum available power, ports priority, maximum allowable power per port.

This section provides PoE (Power over Ethernet) Configuration and PoE output status of PoE Switch, screen in [Figure 4-43](#) appears.

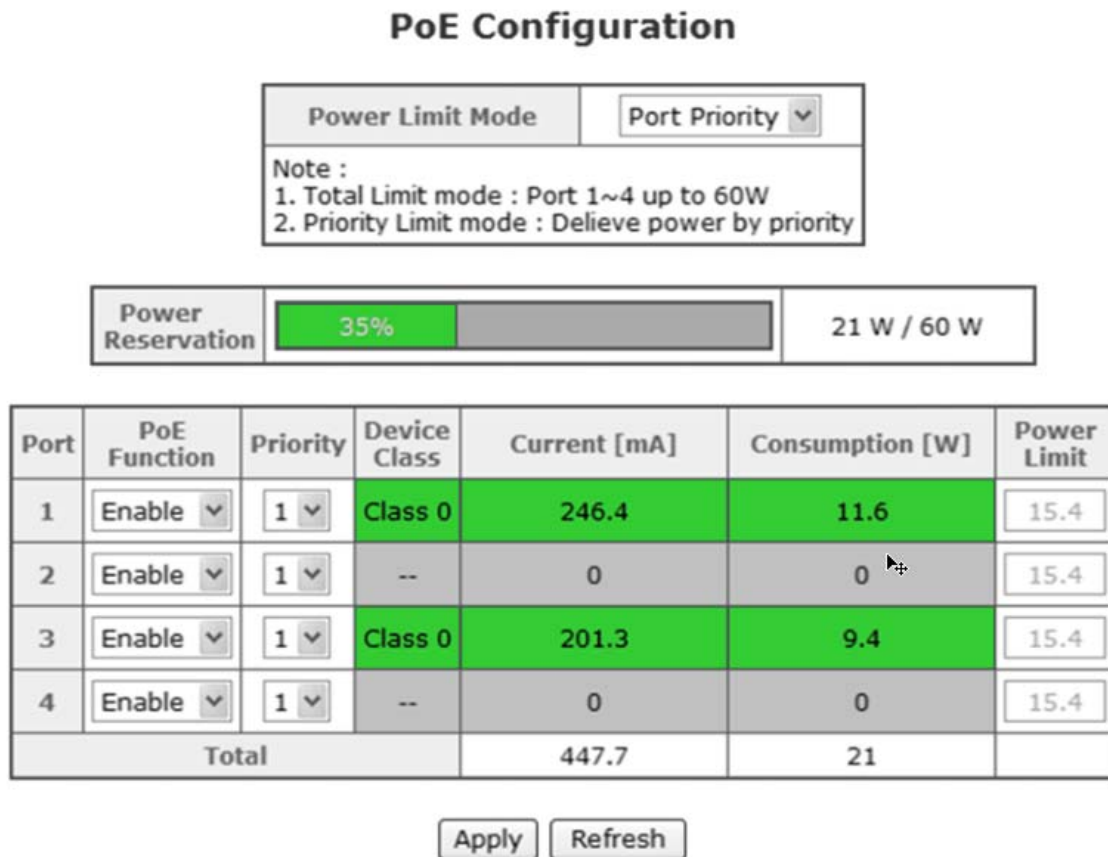

Figure 4-43 PoE Configuration screen

Object	Description
<b>Power limit mode</b>	Allow to configure power limit mode of Web Smart Device. It can choose : <ul style="list-style-type: none"> <li>■ <b>Port Priority</b> Deliver PoE power by port priority setting</li> <li>■ <b>Total Limit</b>. Set limit value of the total POE port provided power to the PDs. For POE-1200, the total PoE power reservation from Port-1~12 is up to 110W For POE-2400, the total PoE power reservation from Port-1~24 is up to 220W</li> </ul>
<b>Power reservation</b>	Show the total watts usage of PoE Switch.
<b>PoE Function</b>	Can enable or disable the PoE function.
<b>Priority</b>	Set port priority for the POE power management It can choose the “ <b>port priority</b> ”, value is “ <b>1~4</b> ”. High priority is “ <b>1</b> ”.
<b>Device class</b>	Class 0 is the default for PDs. However, to improve power management at the PSE, the PD may opt to provide a signature for Class 1 to 3.  The PD is classified based on power. The classification of the PD is the maximum power that the PD will draw across all input voltages and operational modes. A PD shall return Class 0 to 3 in accordance with the maximum power draw as specified by <b>Table 4.1</b> .
<b>Current(mA)</b>	It shows the PoE device current Amp.
<b>Consumption [W]</b>	It shows the PoE device current watt.
<b>Power Limit</b>	It can limit the port PoE supply watts. Per port maximum value must less <b>15.4</b> , total ports values must less than the Power Reservation value.  Once power overload detected, the port will auto shut down and keep on detection mode until PD's power consumption lower than the power limit value.

#### ■ PD Classifications

A PD may be classified by the PSE based on the classification information provided by the PD. The intent of PD classification is to provide information about the maximum power required by the PD during operation. Class 0 is the default for PDs. However, to improve power management at the PSE, the PD may opt to provide a signature for Class 1 to 3.

The PD is classified based on power. The classification of the PD is the maximum power that the PD will draw across all input voltages and operational modes.

A PD shall return Class 0 to 3 in accordance with the maximum power draw as specified by Table 4-1.

Class	Usage	Range of maximum power used by the PD
<b>0</b>	Default	0.44 to 12.95 Watts
<b>1</b>	Optional	0.44 to 3.84 Watts
<b>2</b>	Optional	3.84 to 6.49 Watts
<b>3</b>	Optional	6.49 to 12.95 Watts
<b>4</b>	Not Allowed	Reserved for Future Use

**Table 4.1 Device class**



**Class 4 is defined but is reserved for future use. A Class 4 signature cannot be provided by a compliant PD.**

## 4.10 Logout

Press this function; the Web interface will go back to login screen. The screens in [Figure 4-44](#) and [Figure 4-45](#) appear.



**Figure 4-44** Logout dialogues screen

A screenshot of the BEWARD login screen. At the top left is the BEWARD logo with the tagline "SAFETY & SECURITY". Below the logo is a horizontal bar with a light gray top half and a dark red bottom half. The main content area is white and contains the text "Welcome to BEWARD" in blue, followed by "STW-8P4" in large red font. Below this are two input fields: "USERNAME:" followed by a text box, and "PASSWORD:" followed by a text box. At the bottom, there is contact information: "660118, Russia, Krasnoyarsk region, Krasnoyarsk city, Molokova street 16, apt.355", "Tel: +7(391)278-92-00; +7(495)502-27-29", "Fax: +7(391)277-83-83", and "Email: [beward@beward.ru](mailto:beward@beward.ru)". At the very bottom, it says "Copyright©BEWARD 2014. All rights reserved."

**Figure 4-45** Login screen

## 5. SWITCH OPERATION

### 5.1 Address Table

The Switch is implemented with an address table. This address table composed of many entries. Each entry is used to store the address information of some node in network, including MAC address, port no, etc. This information comes from the learning process of Ethernet Switch.

### 5.2 Learning

When one packet comes in from any port, the Switch will record the source address, port no. And the other related information in address table. This information will be used to decide either forwarding or filtering for future packets.

### 5.3 Forwarding & Filtering

When one packet comes from some port of the Ethernet Switching, it will also check the destination address besides the source address learning. The Ethernet Switching will lookup the address-table for the destination address. If not found, this packet will be forwarded to all the other ports except the port which this packet comes in. And these ports will transmit this packet to the network it connected. If found, and the destination address is located at different port from this packet comes in, the Ethernet Switching will forward this packet to the port where this destination address is located according to the information from address table. But, if the destination address is located at the same port with this packet comes in, then this packet will be filtered, thereby increasing the network throughput and availability.

### 5.4 Store-and-Forward

Store-and-Forward is one type of packet-forwarding techniques. A Store-and Forward Ethernet Switching stores the incoming frame in an internal buffer, do the complete error checking before transmission. Therefore, no error packets occurrence, it is the best choice when a network needs efficiency and stability.

The Ethernet Switch scans the destination address from the packet-header, searches the routing table provided for the incoming port and forwards the packet, only if required. The fast forwarding makes the switch attractive for connecting servers directly to the network, thereby increasing throughput and availability. However, the switch is most commonly used to segment existing hubs, which nearly always improves overall performance. An Ethernet Switching can be easily configured in any Ethernet network environment to significantly boost bandwidth using conventional cabling and adapters.

Due to the learning function of the Ethernet switching, the source address and corresponding port number of each incoming and outgoing packet are stored in a routing table. This information is subsequently used to filter packets whose destination address is on the same segment as the source address. This confines network traffic is to its respective domain, reducing the overall load on the network.

The Switch performs "Store and forward" therefore, no error packets occur. More reliably, it reduces the re-transmission rate. No packet loss will occur.

### 5.5 Auto-Negotiation

The STP ports on the STW-8P4 switch have built-in "Auto-negotiation". This technology automatically sets the best possible bandwidth when a connection is established with another network device (usually at Power On or Reset). Detecting the modes does this and speeds at the second of both devices are connected and capable of, both 10Base-T and 100Base-TX devices can connect with the port in either Half- or Full-duplex mode.

## 6. POWER OVER ETHERNET OVERVIEW

### What is PoE?

Based on the global standard IEEE 802.3af, PoE is a technology for wired Ethernet, the most widely installed local area network technology adopted today. PoE allows the electrical power necessary for the operation of each end-device to be carried by data cables rather than by separate power cords. New network applications, such as IP Cameras, VoIP Phones, and Wireless Networking, can help enterprises improve productivity. It minimizes wires that must be used to install the network for offering lower cost, and less power failures.

IEEE802.3af also called Data Terminal equipment (DTE) power via Media dependent interface (MDI) is an international standard to define the transmission for power over Ethernet. The 802.3af is delivering 48V power over RJ-45 wiring. Besides 802.3af also define two types of source equipment: Mid-Span and End-Span.

#### ■ Mid-Span

Mid-Span device is placed between legacy switch and the powered device. Mid-Span is tap the unused wire pairs 4/5 and 7/8 to carry power, the other four is for data transmit.

#### ■ End-Span

End-Span device is direct connecting with power device. End-Span could also tap the wire 1/2 and 3/6.

### PoE System Architecture

The specification of PoE typically requires two devices: the **Powered Source Equipment (PSE)** and the **Powered Device (PD)**. The PSE is either an End-Span or a Mid-Span, while the PD is a PoE-enabled terminal, such as IP Phones, Wireless LAN, etc. Power can be delivered over data pairs or spare pairs of standard CAT-5 cabling.

### How Power is Transferred Through the Cable

A standard CAT5 Ethernet cable has four twisted pairs, but only two of these are used for 10BASE-T and 100BASE-T. The specification allows two options for using these cables for power, shown in Figure 2 and Figure 3:

The spare pairs are used. Figure 2 shows the pair on pins 4 and 5 connected together and forming the positive supply, and the pair on pins 7 and 8 connected and forming the negative supply. (In fact, a late change to the spec allows either polarity to be used).

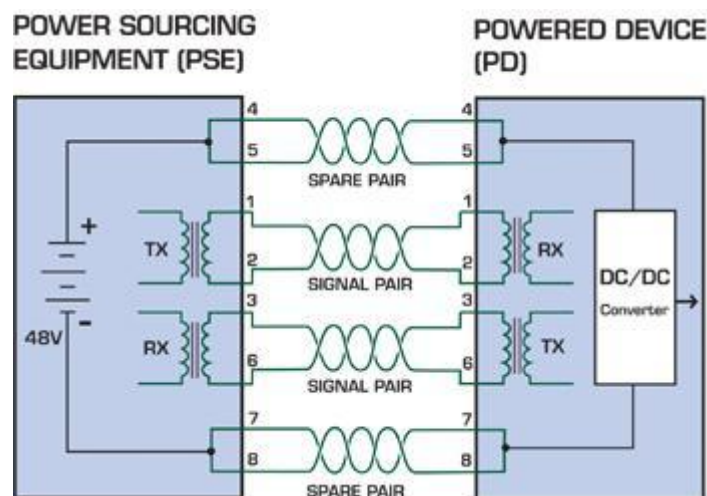

Figure 1 - Power Supplied over the Spare Pins

The data pairs are used. Since Ethernet pairs are transformer coupled at each end, it is possible to apply DC power to the center tap of the isolation transformer without upsetting the data transfer. In this mode of operation the pair on pins 3 and 6 and the pair on pins 1 and 2 can be of either polarity.

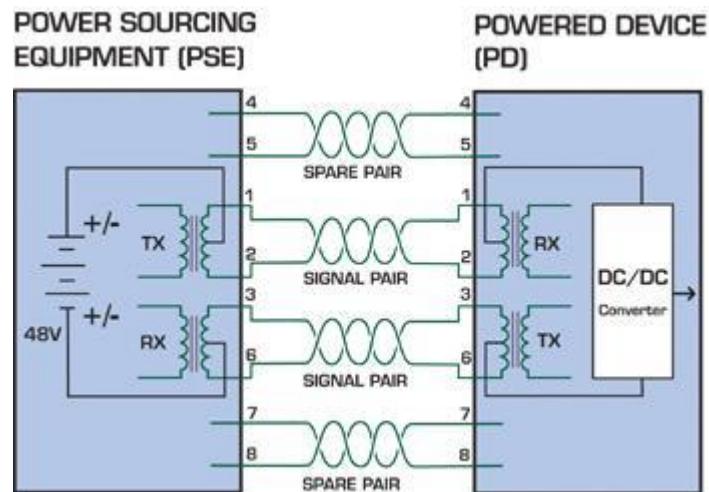

Figure 2 - Power Supplied over the Data Pins

#### When to install PoE?

Consider the following scenarios:

- You're planning to install the latest VoIP Phone system to minimize cabling building costs when your company moves into new offices next month.
- The company staff has been clamoring for a wireless access point in the picnic area behind the building so they can work on their laptops through lunch, but the cost of electrical power to the outside is not affordable.
- Management asks for IP Surveillance Cameras and business access systems throughout the facility, but they would rather avoid another electrician's payment.

#### References:

IEEE Std 802.3af-2003 (Amendment to IEEE Std 802.3-2002, including IEEE Std 802.3ae-2002), 2003 Page(s):0\_1-121

White Paper on Power over Ethernet (IEEE802.3af)

[http://www.poweroverethernet.com/articles.php?article\\_id=52](http://www.poweroverethernet.com/articles.php?article_id=52)

Microsemi /PowerDsine

<http://www.microsemi.com/PowerDsine/>

Linear Tech

<http://www.linear.com/>

## 7. THE POE PROVISION PROCESS

While adding PoE support to networked devices is relatively painless, it should be realized that power cannot simply be transferred over existing CAT-5 cables. Without proper preparation, doing so may result in damage to devices that are not designed to support provision of power over their network interfaces.

The PSE is the manager of the PoE process. In the beginning, only small voltage level is induced on the port's output, till a valid PD is detected during the Detection period. The PSE may choose to perform classification, to estimate the amount of power to be consumed by this PD. After a time-controlled start-up, the PSE begins supplying the 48 VDC level to the PD, till it is physically or electrically disconnected. Upon disconnection, voltage and power shut down.

Since the PSE is responsible for the PoE process timing, it is the one generating the probing signals prior to operating the PD and monitoring the various scenarios that may occur during operation.

All probing is done using voltage induction and current measurement in return.

### Stages of powering up a PoE link

Stage	Action	Volts specified per 802.3af	Volts managed by chipset
<b>Detection</b>	Measure whether powered device has the correct signature resistance of 15–33 kΩ	2.7-10.0	1.8–10.0
<b>Classification</b>	Measure which power level class the resistor indicates	14.5-20.5	12.5–25.0
<b>Startup</b>	Where the powered device will startup	>42	>38
<b>Normal operation</b>	Supply power to device	36-57	25.0–60.0

### 7.1 Line Detection

Before power is applied, safety dictates that it must first be ensured that a valid PD is connected to the PSE's output. This process is referred to as "line detection", and involves the PSE seeking a specific, 25 KΩ signature resistor. Detection of this signature indicates that a valid PD is connected, and that provision of power to the device may commence.

The signature resistor lies in the PD's PoE front-end, isolated from the rest of the the PD's circuitries till detection is certified.

### 7.2 Classification

Once a PD is detected, the PSE may optionally perform classification, to determine the maximal power a PD is to consume. The PSE induces 15.5-20.5 VDC, limited to 100 mA, for a period of 10 to 75 ms responded by a certain current consumption by the PD, indicating its power class.

The PD is assigned to one of 5 classes: 0 (default class) indicates that full 15.4 watts should be provided, 1-3 indicate various required power levels and 4 is reserved for future use. PDs that do not support classification are assigned to class 0. Special care must be employed in the definition of class thresholds, as classification may be affected by cable losses.

Classifying a PD according to its power consumption may assist a PoE system in optimizing its power distribution. Such a system typically suffers from lack of power resources, so that efficient power management based on classification results may reduce total system costs.



### **7.3 Start-up**

Once line detection and optional classification stages are completed, the PSE must switch from low voltage to its full voltage capacity (44-57 Volts) over a minimal amount of time (above 15 microseconds).

A gradual startup is required, as a sudden rise in voltage (reaching high frequencies) would introduce noise on the data lines.

Once provision of power is initiated, it is common for inrush current to be experienced at the PSE port, due to the PD's input capacitance. A PD must be designed to cease inrush current consumption (of over 350 mA) within 50 ms of power provision startup.

### **7.4 Operation**

During normal operation, the PSE provides 44-57 VDC, able to support a minimum of 15.4 watts power.

#### ***Power Overloads***

The IEEE 802.3af standard defines handling of overload conditions. In the event of an overload (a PD drawing a higher power level than the allowed 12.95 Watts), or an outright short circuit caused by a failure in cabling or in the PD, the PSE must shut down power within 50 to 75 milliseconds, while limiting current drain during this period to protect the cabling infrastructure. Immediate voltage drop is avoided to prevent shutdown due to random fluctuations.

### **7.5 Power Disconnection Scenarios**

The IEEE 802.3af standard requires that devices powered over Ethernet be disconnected safely (i.e. power needs be shut down within a short period of time following disconnection of a PD from an active port).

When a PD is disconnected, there is a danger that it will be replaced by a non-PoE-ready device while power is still on. Imagine disconnecting a powered IP phone utilizing 48 VDC, then inadvertently plugging the powered Ethernet cable into a non-PoE notebook computer. What's sure to follow is not a pretty picture.

The standard defines two means of disconnection, DC Disconnect and AC Disconnect, both of which provide the same functionality - the PSE shuts down power to a disconnected port within 300 to 400ms. The upper boundary is a physical human limit for disconnecting one PD and reconnecting another.

#### ***DC Disconnect***

DC Disconnect detection involves measurement of current. Naturally, a disconnected PD stops consuming current, which can be inspected by the PSE. The PSE must therefore disconnect power within 300 to 400 ms from the current flow stop. The lower time boundary is important to prevent shutdown due to random fluctuations.

#### ***AC Disconnect***

This method is based on the fact that when a valid PD is connected to a port, the AC impedance measured on its terminals is significantly lower than in the case of an open port (disconnected PD).

AC Disconnect detection involves the induction of low AC signal in addition to the 48 VDC operating voltage. The returned AC signal amplitude is monitored by the PSE at the port terminals. During normal operation, the PD's relatively low impedance lowers the returned AC signal while a sudden disconnection of this PD will cause a surge to the full AC signal level and will indicate PD disconnection.

## 8.TROUBLESHOOTING

This chapter contains information to help you solve problems. If the Switch is not functioning properly, make sure the Ethernet Switch was set up according to instructions in this manual.

### **The Link LED is not lit**

**Solution:**

Check the cable connection and remove duplex mode of the Switch.

### **Some stations cannot talk to other stations located on the other port**

**Solution:**

Please check the VLAN, port security function that may introduce this kind of problem.

### **Performance is bad**

**Solution:**

Check the full duplex status of the Ethernet Switch. If the Ethernet Switch is set to full duplex and the partner is set to half duplex, then the performance will be poor.

### **100Base-TX port link LED is lit, but the traffic is irregular**

**Solution:**

Check that the attached device is not set to dedicate full duplex. Some devices use a physical or software switch to change duplex modes. Auto-negotiation may not recognize this type of full-duplex setting.

### **Why the Switch doesn't connect to the network**

**Solution:**

Check the LNK/ACT LED on the switch Try another port on the Switch Make sure the cable is installed properly Make sure the cable is the right type Turn off the power. After a while, turn on power again.

### **Why I connect my PoE device to STW-8P4 and it cannot power on?**

**Solution:**

1. Please check the cable type of the connection from STW-8P4 (port 1 to port 4) to the other end. The cable should be an 8-wire UTP, Category 5 or above, EIA568 cable within 100 meters. A cable with only 4-wire, short loop or over 100 meters, all will affect the power supply.
2. Please check and assure the device that fully complied with IEEE 802.3af standard.

### **What is the power output of each IEEE 802.af PoE port?**

**Solution:**

Each PoE port supports **48VDC, 350mA, max 15.4 watts** power output. Detect and inject by the standard of IEEE 802.3af.

## APPENDIX A NETWORKING CONNECTION

### A.1 DATA OUT PoE Switch RJ-45 Port Pin Assignments (Port 1 to Port-4)

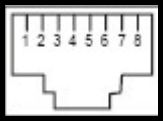
	PIN NO	RJ-45 SIGNAL ASSIGNMENT
	1	<ul style="list-style-type: none"> <li>• Output Transmit Data +</li> <li>• Power +</li> </ul>
	2	<ul style="list-style-type: none"> <li>• Output Transmit Data –</li> <li>• Power +</li> </ul>
	3	<ul style="list-style-type: none"> <li>• Receive Data +</li> <li>• Power -</li> </ul>
	4	-
	5	-
	6	<ul style="list-style-type: none"> <li>• Receive Data –</li> <li>• Power -</li> </ul>
	7	-
	8	-

### A.2 Switch's RJ-45 Pin Assignments (Port-5 to Port-8)

Contact	MDI	MDI-X
1	1 (TX +)	3
2	2 (TX -)	6
3	3 (RX +)	1
6	6 (RX -)	2
4, 5, 7, 8	Not used	Not used

### A.3 RJ-45 cable pin assignment

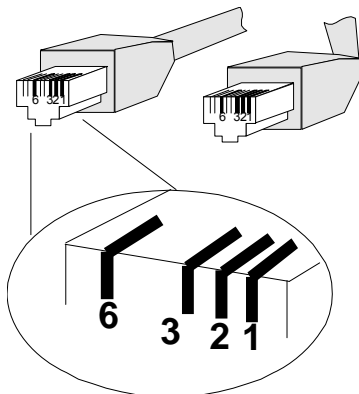

There are 8 wires on a standard UTP/STP cable and each wire is color-coded. The following shows the pin allocation and color of straight cable and crossover cable connection:

<u>Straight Cable</u>		<u>SIDE 1</u>	<u>SIDE2</u>
	<p><b>SIDE 1</b></p> <p><b>SIDE 2</b></p>	<p>1 = White / Orange</p> <p>2 = Orange</p> <p>3 = White / Green</p> <p>4 = Blue</p> <p>5 = White / Blue</p> <p>6 = Green</p> <p>7 = White / Brown</p> <p>8 = Brown</p>	<p>1 = White / Orange</p> <p>2 = Orange</p> <p>3 = White / Green</p> <p>4 = Blue</p> <p>5 = White / Blue</p> <p>6 = Green</p> <p>7 = White / Brown</p> <p>8 = Brown</p>
<u>Straight Cable</u>		<u>SIDE 1</u>	<u>SIDE2</u>
	<p><b>SIDE 1</b></p> <p><b>SIDE 2</b></p>	<p>1 = White / Orange</p> <p>2 = Orange</p> <p>3 = White / Green</p> <p>4 = Blue</p> <p>5 = White / Blue</p> <p>6 = Green</p> <p>7 = White / Brown</p> <p>8 = Brown</p>	<p>1 = White / Orange</p> <p>2 = Green</p> <p>3 = White / Orange</p> <p>4 = Blue</p> <p>5 = White / Blue</p> <p>6 = Orange</p> <p>7 = White / Brown</p> <p>8 = Brown</p>

**Figure A-1: Straight-Through and Crossover Cable**

Please make sure your connected cables are with same pin assignment and color as above picture before deploying the cables into your network.

## APPENDIX B

## B.1 Power over Ethernet Compatibility test

No.	PDs	PoE Output	Note
1	[BEWARD POE-151S-12V] + [BEWARD ICA-500]	9.6W	
2	[BEWARD POE-151S-12V] + BEWARD ICA310	6.4W	Standby
3	[BEWARD POE-152S-12V] + [BEWARD ICA-500]	7.3W	
4	[BEWARD POE-151S-12] + CAM-IR338-NT	5.1W	LED Off
5	[BEWARD POE-151S-12] + CAM-IR338-NT	13.5W~14.3W	LED On
6	BEWARD VIP-155PT	3W	
7	BEWARD VIP-154PT	4.9W~5.6W	
8	BEWARD VIP-550PT	4~4.5W	
9	BEWARD WAP-4060PE	4.3W	Standby
10	BEWARD FSD-803PE	2.2W	Standby
11	BEWARD IVS-110	6.1W	Standby
12	BEWARD ICA-510	4.2W	Standby
13	BEWARD ICA-700	3.7W	Standby
14	BEWARD ICA-750	5.2W	Standby
15	BEWARD ICA-107P	5.1W	Standby
16	BEWARD ICA-310	11.2W	Standby

